







PORTELLA OVALE apertura interna

-  OVAL Manwaydoor inwards opening
-  Porte OVALE avec ouverture à l'intérieur
-  Puerta OVAL de apertura interna
-  OVALE Mannlochtür schwenkbar nach innen
-  ОВАЛЬНАЯ КРЫШКА с внутренним открытием
-  内开椭圆形人孔门

304 ART
305 X 430 mm
 Rev 0



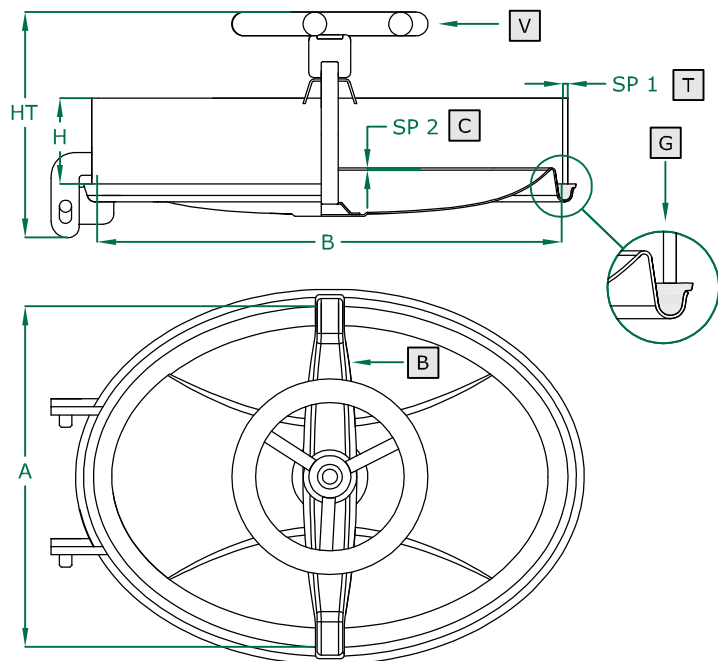



COPERCHIO COVER	C
TELAIO FRAME	T
BRACCIO ARM	B
VOLANTINO HANDWHEEL	V
GUARNIZIONE GASKET	G



	STANDARD		OPTIONAL			
H X SP1	60 X 6	80 X 6	100 X 6	150 X 6	...	
TELAIO	SAT			MPL		
GUARNIZIONE	PARA	EPDM	NEOPRENE	NBR	SILICONE	VITON
VOLANTINO	125 004 V NYLON			125 034 S. STEEL		

ART	A	B	SP2	HT (standard)	BAR max: (standard)	COVER type:	GASKET code:	KG (standard)
304	305	430	1,5	165	1,5	CN	120 618	7,0
304R	305	430	2,0	165	2	CN	120 618	7,9

PORTELLA OVALE apertura interna

-  OVAL Manwaydoor inwards opening
-  Porte OVALE avec ouverture à l'intérieur
-  Puerta OVAL de apertura interna
-  OVALE Mannlochtür schwenkbar nach innen
-  ОВАЛЬНАЯ КРЫШКА с внутренним открытием
-  内开椭圆形人孔门

306 ART
305 X 430 mm
 Rev 02



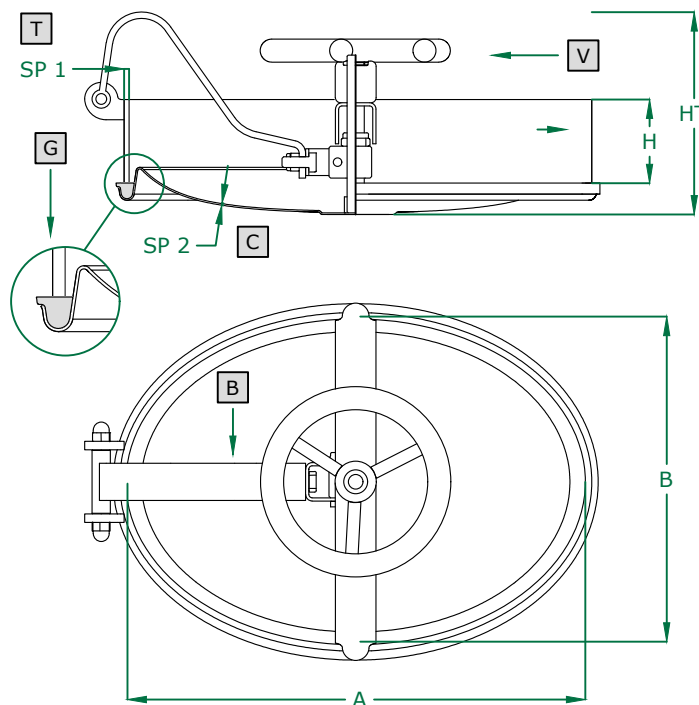



COPERCHIO COVER	C
TELAIO FRAME	T
BRACCIO ARM	B
VOLANTINO HANDWHEEL	V
GUARNIZIONE GASKET	G



	STANDARD		OPTIONAL			
H X SP1	60 X 6	80 X 6	100 X 6			
TELAIO	SAT		MPL			
GUARNIZIONE	PARA	EPDM	NEOPRENE	NBR	SILICONE	VITON
VOLANTINO	125 004 V NYLON		125 034 S. STEEL			

ART	A	B	SP2	HT (standard)	BAR max: (standard)	COVER type:	GASKET code:	KG (standard)
306	305	430	1,5	165	2,0	CN	120 618	7,1
306R	305	430	2,0	165	2,0	CN	120 618	8,0

PORTELLA OVALE apertura interna

-  OVAL Manwaydoor inwards opening
-  Porte OVALE avec ouverture à l'intérieur
-  Puerta OVAL de apertura interna
-  OVALE Mannlochtür schwenkbar nach innen
-  ОВАЛЬНАЯ КРЫШКА с внутренним открытием
-  内开椭圆形人孔门

307 ART
305 X 430 mm
 Rev 02



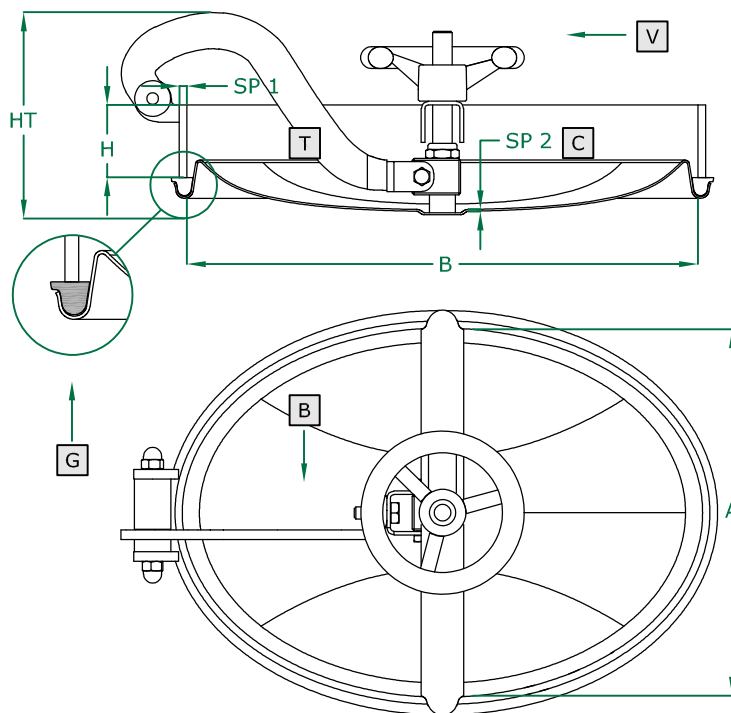



COPERCHIO COVER	C
TELAIO FRAME	T
BRACCIO ARM	B
VOLANTINO HANDWHEEL	V
GUARNIZIONE GASKET	G



	STANDARD		OPTIONAL			
H X SP1	60 X 6	80 X 6	100 X 6			
TELAIO	SAT		MPL			
GUARNIZIONE	PARA	EPDM	NEOPRENE	NBR	SILICONE	VITON
VOLANTINO	125 004 V NYLON		125 034 S. STEEL			

ART	A	B	SP2	HT (standard)	BAR max: (standard)	COVER type:	GASKET code:	KG (standard)
307	305	430	1,5	165	2,0	CN	120 618	7,0
307R	305	430	2,0	165	2,0	CN	120 618	7,9

PORTELLA OVALE apertura interna

-  OVAL Manwaydoor inwards opening
-  Porte OVALE avec ouverture à l'intérieur
-  Puerta OVAL de apertura interna
-  OVALE Mannlochtür schwenkbar nach innen
-  ОВАЛЬНАЯ КРЫШКА с внутренним открытием
-  内开椭圆形人孔门

D. = Rag. minima Ø 900

308 ART
345 X 445 mm
Rev 1



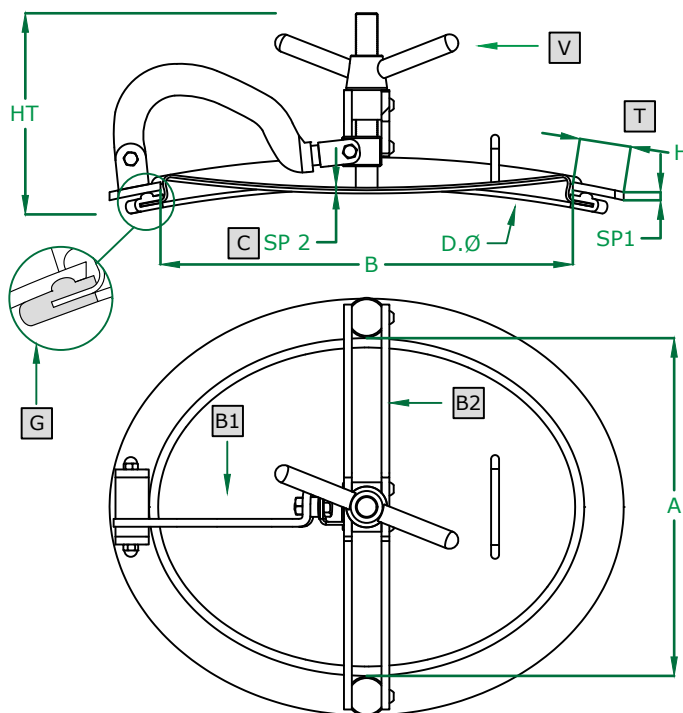



COPERCHIO COVER	C
TELAIO FRAME	T
BRACCIO1 ARM 1	B1
BRACCIO2 ARM 2	B2
VOLANTINO HANDWHEEL	V
GUARNIZIONE GASKET	G



	STANDARD	OPTIONAL				
H X SP1	40 X 8	Ø ≥ D.900				
TELAIO	SAT	MPL				
GUARNIZIONE	PARA	EPDM	NEOPRENE	NBR	SILICONE	VITON
VOLANTINO	125 037 S. STEEL M22					

ART	A	B	SP2	HT (standard)	BAR max: (standard)	COVER type:	GASKET code:	KG (standard)
308	345	445	3,0	175	3,0	CL	120 750	12
308 R	345	445	4,0	175	3,5	CL	120 750	13

PORTELLA OVALE apertura interna

-  OVAL Manwaydoor inwards opening
-  Porte OVALE avec ouverture à l'intérieur
-  Puerta OVAL de apertura interna
-  OVALE Mannlochtür schwenkbar nach innen
-  ОВАЛЬНАЯ КРЫШКА с внутренним открытием
-  内开椭圆形人孔门

D. = Rag. minima Ø 900

309 ART
345 X 445 mm
 Rev 3



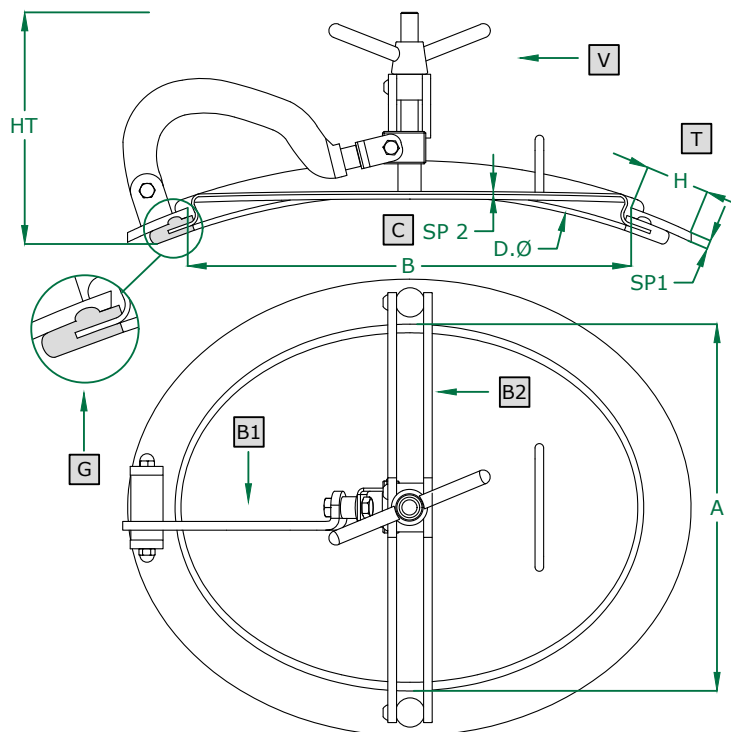



COPERCHIO COVER	C
TELAIO FRAME	T
BRACCIO1 ARM 1	B1
BRACCIO2 ARM 2	B2
VOLANTINO HANDWHEEL	V
GUARNIZIONE GASKET	G



	STANDARD	OPTIONAL				
H X SP1	40 X 8	Ø ≥ D.900				
TELAIO	SAT	MPL				
GUARNIZIONE	PARA	EPDM	NEOPRENE	NBR	SILICONE	VITON
VOLANTINO	125 034 S. STEEL M16	125 004 V NYLON				

ART	A	B	SP2	HT (standard)	BAR max: (standard)	COVER type:	GASKET code:	KG (standard)
309	345	445	2,5	170	3,0	CL	120 750	11,0

PORTELLA OVALE apertura interna

-  OVAL Manwaydoor inwards opening
-  Porte OVALE avec ouverture à l'intérieur
-  Puerta OVAL de apertura interna
-  OVALE Mannlochtür schwenkbar nach innen
-  ОВАЛЬНАЯ КРЫШКА с внутренним открытием
-  内开椭圆形人孔门



310 ART

400 X 490 mm

Rev 0

Pressure Equipment Directive
PED - 97/23/CE

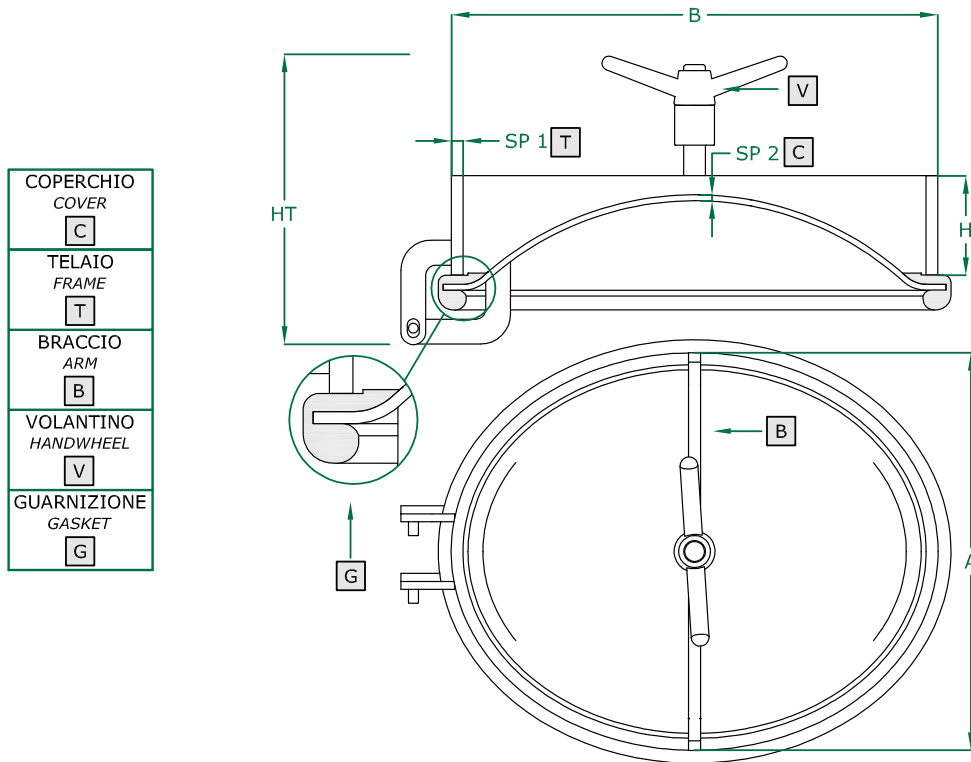







COPERCHIO COVER	C
TELAIO FRAME	T
BRACCIO ARM	B
VOLANTINO HANDWHEEL	V
GUARNIZIONE GASKET	G



	STANDARD	OPTIONAL			
H X SP1	100 X 12	130 X 12	150 X 12	200 X 12	
TELAIO	SAT		MPL		
GUARNIZIONE	EPDM	NBR	SILICONE	VITON	
VOLANTINO	125 037 S. STEEL				

ART	A	B	SP2	HT (standard)	BAR max: (standard)	COVER type:	GASKET code:	KG (standard)
310	400	490	6	300	10,0	CL	120 631	26,0

PORTELLA OVALE apertura esterna

-  OVAL manwaydoor outwards opening
-  Porte ovale avec ouverture à l'extérieur
-  Puerta oval de apertura externa
-  OVALE Mannlochverschluß, Aussenöffnung
-  ОБАЛЬНАЯ КРЫШКА с внешним открытием
-  外开椭圆形人孔门

311 ART
305 X 430 mm
 Rev 0



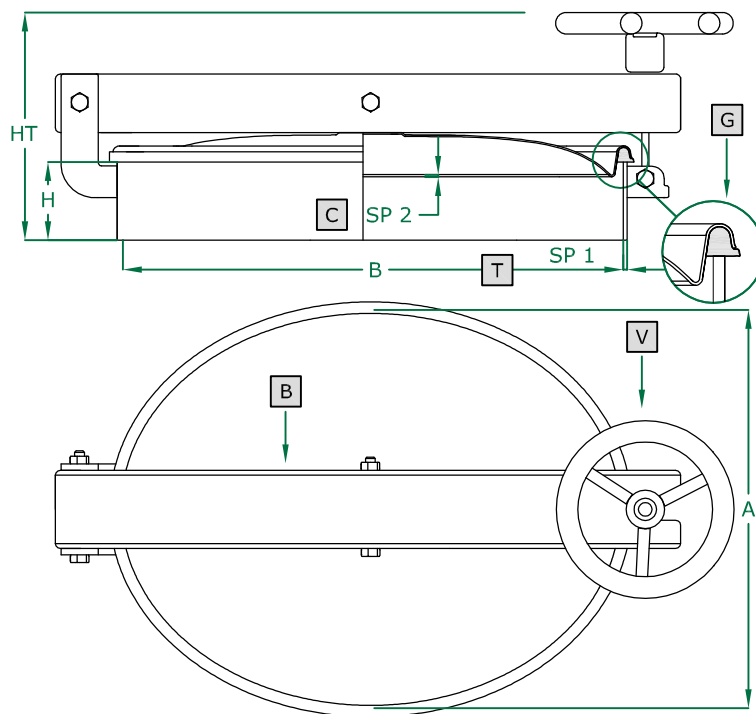



COPERCHIO COVER	C
TELAIO FRAME	T
BRACCIO ARM	B
VOLANTINO HANDWHEEL	V
GUARNIZIONE GASKET	G



	STANDARD		OPTIONAL			
H X SP1	60 x 6	80 x 6	100 x 6		150 x 6	
TELAIO	SAT		MPL			
GUARNIZIONE	PARA	EPDM	NEOPRENE	NBR	SILICONE	VITON
VOLANTINO	125 011 V NYLON		125 033 S. STEEL			

ART	A	B	SP2	HT (standard)	BAR max: (standard)	COVER type:	GASKET code:	KG (standard)
311	305	430	2	210	0,4	CN	120 618	11

PORTELLA OVALE apertura esterna e bandiera

-  OVAL manwaydoor outwards opening with rotatable system
-  Porte ovale avec ouverture à l'extérieur avec système rotatif
-  Puerta oval de apertura externa y giratoria
-  OVALE Mannlochverschluß, Aussenöffnung mit rotierendem System
-  ОВАЛЬНАЯ КРЫШКА с внешним открытием
-  外开椭圆形人孔门



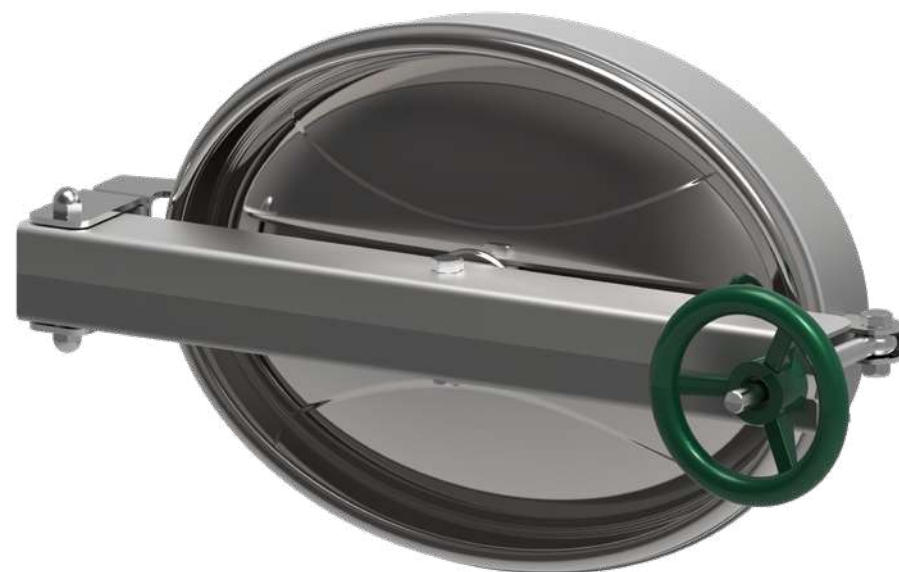
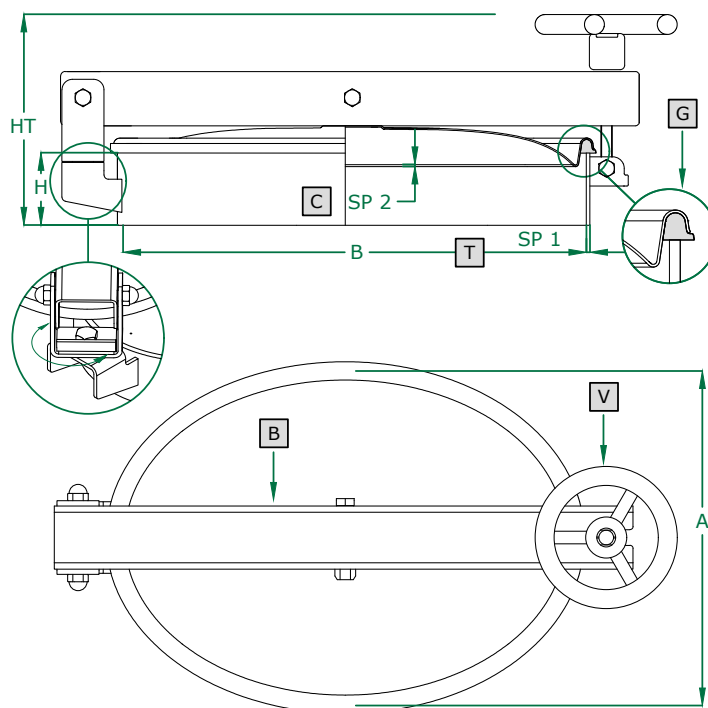



COPERCHIO COVER	C
TELAIO FRAME	T
BRACCIO ARM	B
VOLANTINO HANDWHEEL	V
GUARNIZIONE GASKET	G



	STANDARD		OPTIONAL			
H X SP1	60 x 6	80 x 6	100 x 6	150 x 6		
TELAIO	SAT		MPL			
GUARNIZIONE	PARA	EPDM	NEOPRENE	NBR	SILICONE	VITON
VOLANTINO	125 011 V NYLON		125 033 S. STEEL			

ART	A	B	SP2	HT (standard)	BAR max: (standard)	COVER type:	GASKET code:	KG (standard)
311G	305	430	2	210	0,4	CN	120 618	11

PORTELLA OVALE apertura interna

-  OVAL Manwaydoor inwards opening
-  Porte OVALE avec ouverture à l'intérieur
-  Puerta OVAL de apertura interna
-  OVALE Mannlochtür schwenkbar nach innen
-  ОВАЛЬНАЯ КРЫШКА с внутренним открытием
-  内开椭圆形人孔门

312 ART
305 X 430 mm
 Rev 2

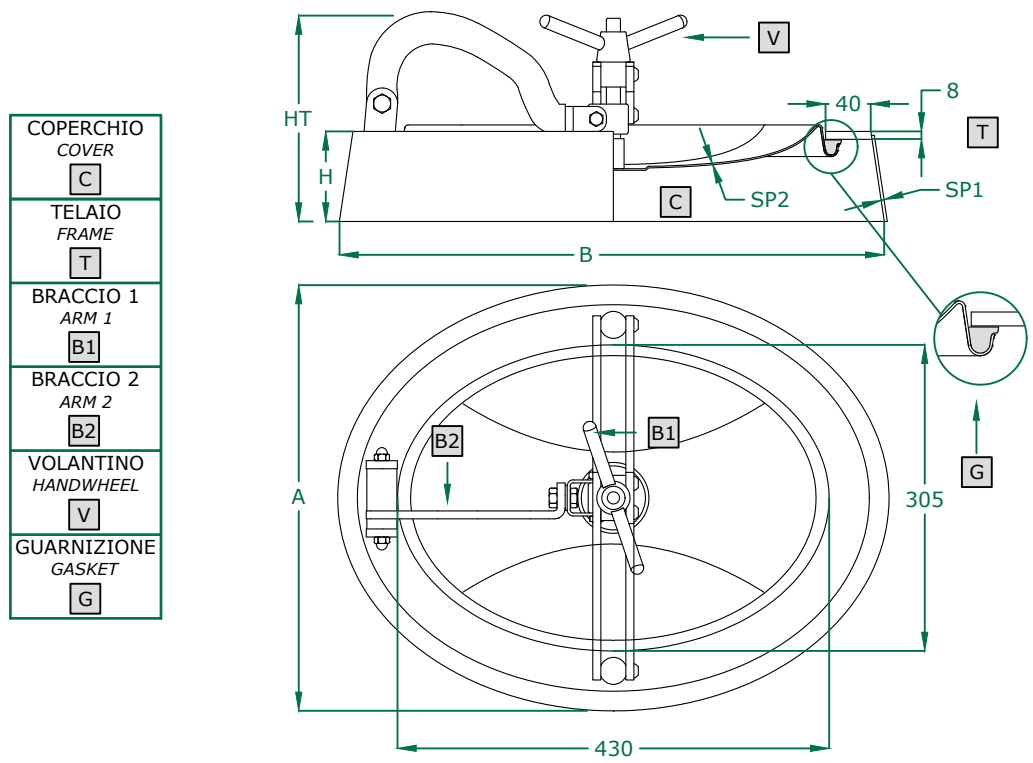







COPERCHIO COVER	C
TELAIO FRAME	T
BRACCIO 1 ARM 1	B1
BRACCIO 2 ARM 2	B2
VOLANTINO HANDWHEEL	V
GUARNIZIONE GASKET	G



	STANDARD	OPTIONAL				
H X SP1	90 X 3	130 x 3 - RAGGIATURA				
TELAIO	SAT			MPL		
GUARNIZIONE	PARA	EPDM	NEOPRENE	NBR	SILICONE	VITON
VOLANTINO	125 034 S. STEEL			125 004 V NYLON		

ART	A	B	SP2	HT (standard)	BAR max: (standard)	COVER type:	GASKET code:	KG (standard)
312	415	540	2,0	153	2,5	CN	120 618	11,5

PORTELLA OVALE apertura interna

-  OVAL Manwaydoor inwards opening
-  Porte OVALE avec ouverture à l'intérieur
-  Puerta OVAL de apertura interna
-  OVALE Mannlochtür schwenkbar nach innen
-  ОВАЛЬНАЯ КРЫШКА с внутренним открытием
-  内开椭圆形人孔门



314 ART

400 X 490 mm

Rev 0



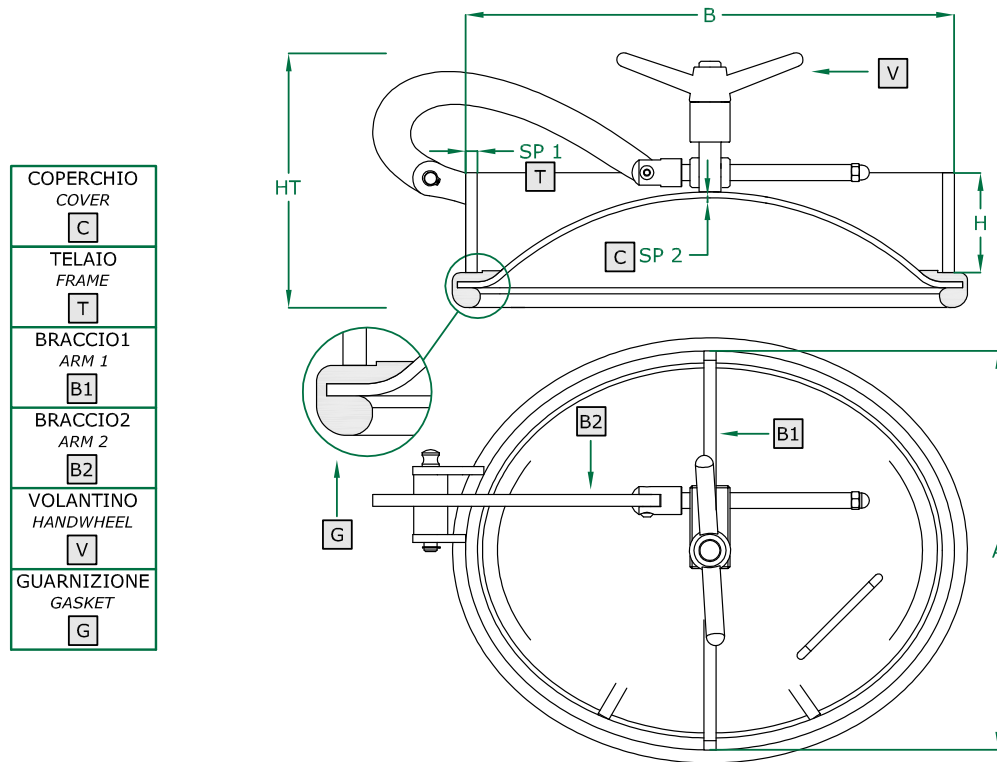



Pressure Equipment Directive
PED - 97/23/CE



	STANDARD	OPTIONAL			
H X SP1	100 X 12	130 X 12	150 X 12	200 X 12	
TELAIO	SAT		MPL		
GUARNIZIONE	EPDM	NBR	SILICONE	VITON	
VOLANTINO	125 037 S. STEEL				

ART	A	B	SP2	HT (standard)	BAR max: (standard)	COVER type:	GASKET code:	KG (standard)
314	400	490	6	270	10,0	CL	120 631	28,0

PORTELLA OVALE apertura interna

-  OVAL Manwaydoor inwards opening
-  Porte OVALE avec ouverture à l'intérieur
-  Puerta OVAL de apertura interna
-  OVALE Mannlochtür schwenkbar nach innen
-  ОВАЛЬНАЯ КРЫШКА с внутренним открытием
-  内开椭圆形人孔门



315 ART

400 X 490 mm

Rev 0



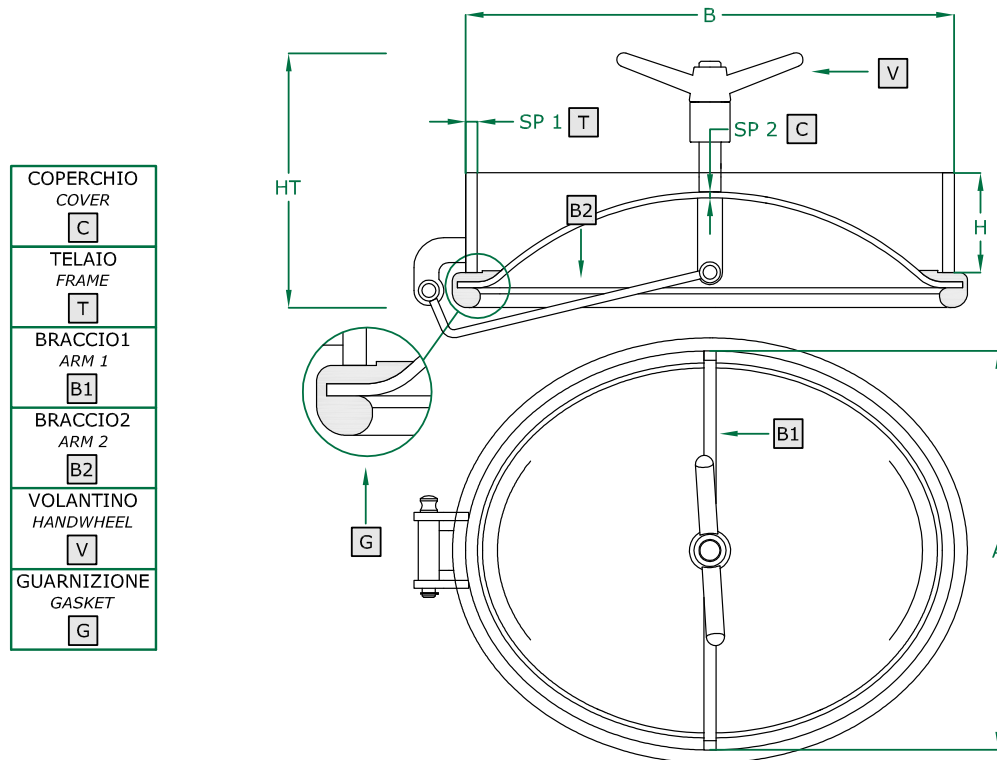



Pressure Equipment Directive
PED - 97/23/CE



	STANDARD	OPTIONAL			
H X SP1	100 X 12	130 X 12	150 X 12	200 X 12	
TELAIO	SAT		MPL		
GUARNIZIONE	EPDM	NBR	SILICONE	VITON	
VOLANTINO	125 037 S. STEEL				

ART	A	B	SP2	HT (standard)	BAR max: (standard)	COVER type:	GASKET code:	KG (standard)
315	400	490	6	290	10,0	CL	120 631	27,0

PORTELLA OVALE apertura interna

-  OVAL Manwaydoor inwards opening
-  Porte OVALE avec ouverture à l'intérieur
-  Puerta OVAL de apertura interna
-  OVALE Mannlochtür schwenkbar nach innen
-  ОВАЛЬНАЯ КРЫШКА с внутренним открытием
-  内开椭圆形人孔门



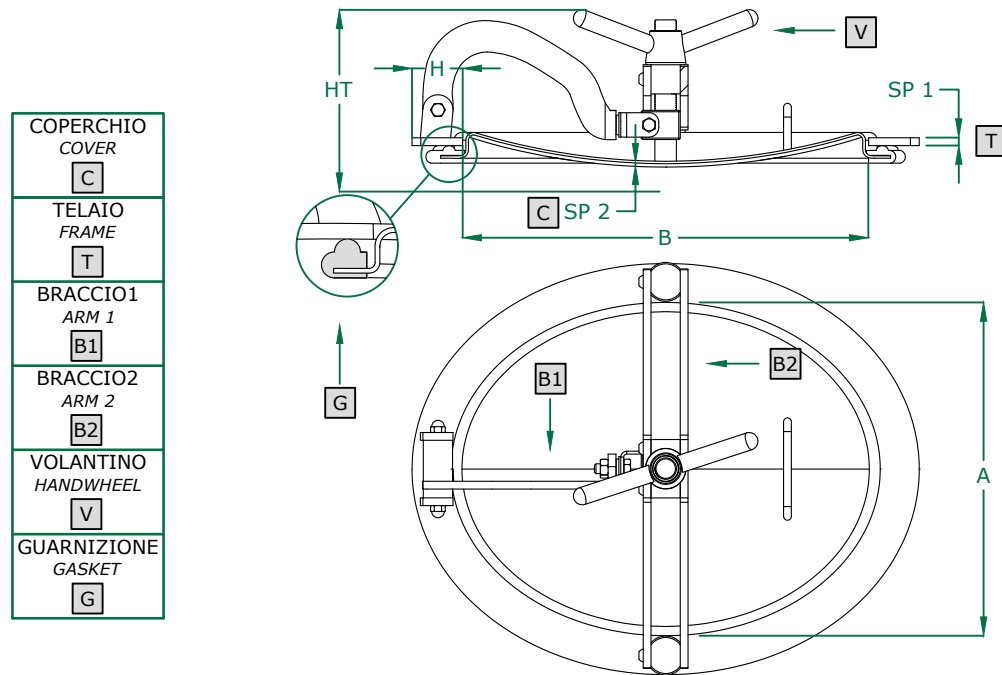



316 ART
345 X 445 mm
Rev 1



	STANDARD	OPTIONAL				
H X SP1	40 X 8					
TELAIO	SAT			MPL		
GUARNIZIONE	PARA	EPDM	NEOPRENE	NBR	SILICONE	VITON
VOLANTINO	125 037 S. STEEL M22					

ART	A	B	SP2	HT (standard)	BAR max: (standard)	COVER type:	GASKET code:	KG (standard)
316	345	445	3,0	175	3,0	CL	120 750	12
316R	345	445	4,0	175	3,5	CL	120 750	13

PORTELLA OVALE apertura interna

-  OVAL Manwaydoor inwards opening
-  Porte OVALE avec ouverture à l'intérieur
-  Puerta OVAL de apertura interna
-  OVALE Mannlochtür schwenkbar nach innen
-  ОВАЛЬНАЯ КРЫШКА с внутренним открытием
-  内开椭圆形人孔门

317 ART
345 X 445 mm
 Rev 0

COPERCHIO COVER	C
TELAIO FRAME	T
BRACCIO ARM	B
VOLANTINO HANDWHEEL	V
GUARNIZIONE GASKET	G

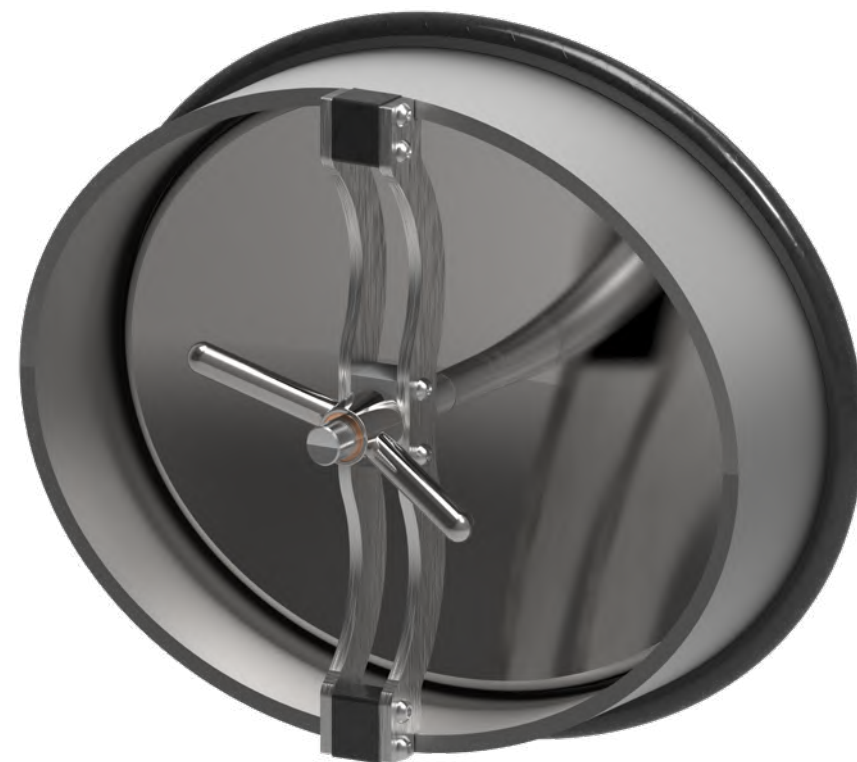
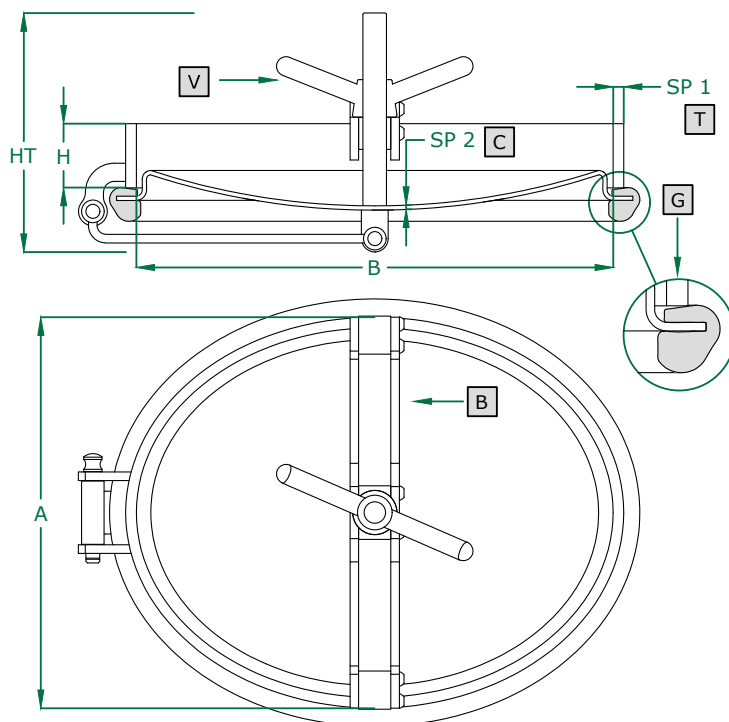







	STANDARD	OPTIONAL			
H X SP1	60 X 10	80 X 10	100 X 10	130 X 10	...
TELAIO	SAT			MPL	
GUARNIZIONE	EPDM	NBR	SILICONE	VITON	
VOLANTINO	125 037 S. STEEL M 22				

ART	A	B	SP2	HT (standard)	BAR max: (standard)	COVER type:	GASKET code:	KG (standard)
317	345	445	4	223	5,0	CL	120 622	16,8

317E ART

345 X 445 mm
Rev 0

PORTELLA OVALE apertura interna

-  OVAL Manwaydoor inwards opening
-  Porte OVALE avec ouverture à l'intérieur
-  Puerta OVAL de apertura interna
-  OVALE Mannlochtür schwenkbar nach innen
-  ОВАЛЬНАЯ КРЫШКА с внутренним открытием
-  内开椭圆形人孔门



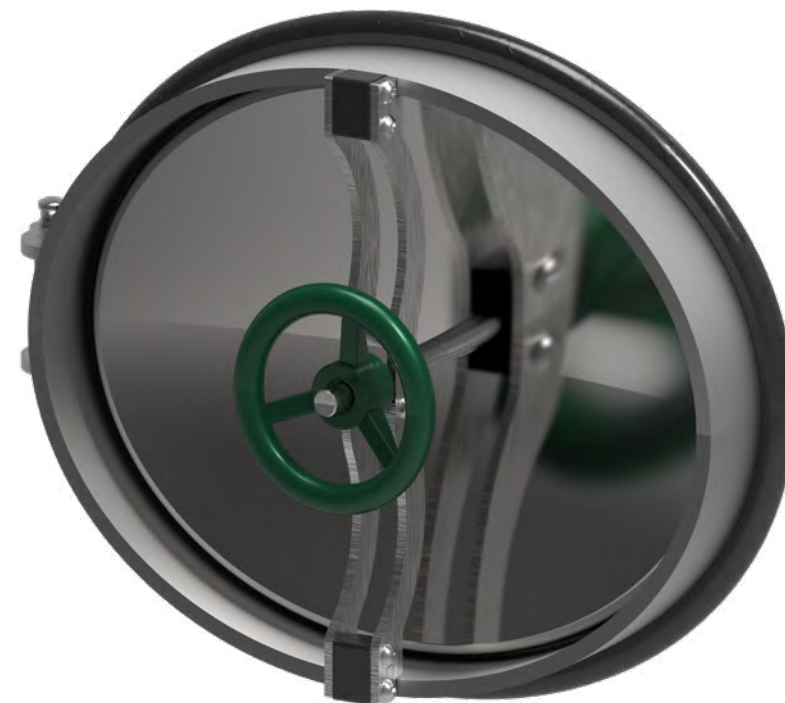
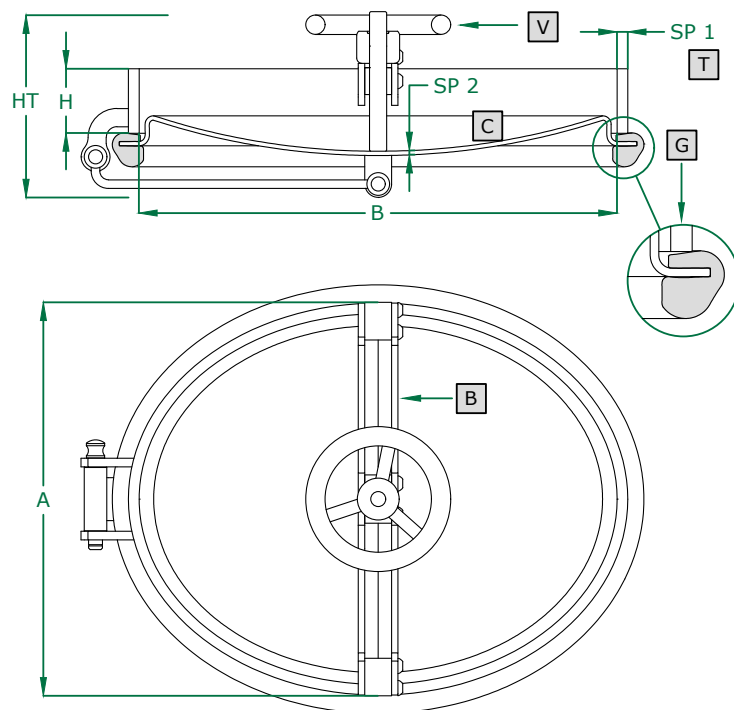



COPERCHIO COVER	C
TELAIO FRAME	T
BRACCIO ARM	B
VOLANTINO HANDWHEEL	V
GUARNIZIONE GASKET	G



	STANDARD	OPTIONAL			
H X SP1	60 X 10	80 X 10	100 X 10	130 X 10	...
TELAIO	SAT			MPL	
GUARNIZIONE	EPDM	NBR		SILICONE	VITON
VOLANTINO	125 004 V	125034 S. STEEL M16			

ART	A	B	SP2	HT (standard)	BAR max: (standard)	COVER type:	GASKET code:	KG (standard)
317E	345	445	4	173	5,0	CL	120 622	15,5

PORTELLA OVALE apertura interna

-  OVAL Manwaydoor inwards opening
-  Porte OVALE avec ouverture à l'intérieur
-  Puerta OVAL de apertura interna
-  OVALE Mannlochtür schwenkbar nach innen
-  ОВАЛЬНАЯ КРЫШКА с внутренним открытием
-  内开椭圆形人孔门

318 ART
345 X 445 mm
 Rev 1



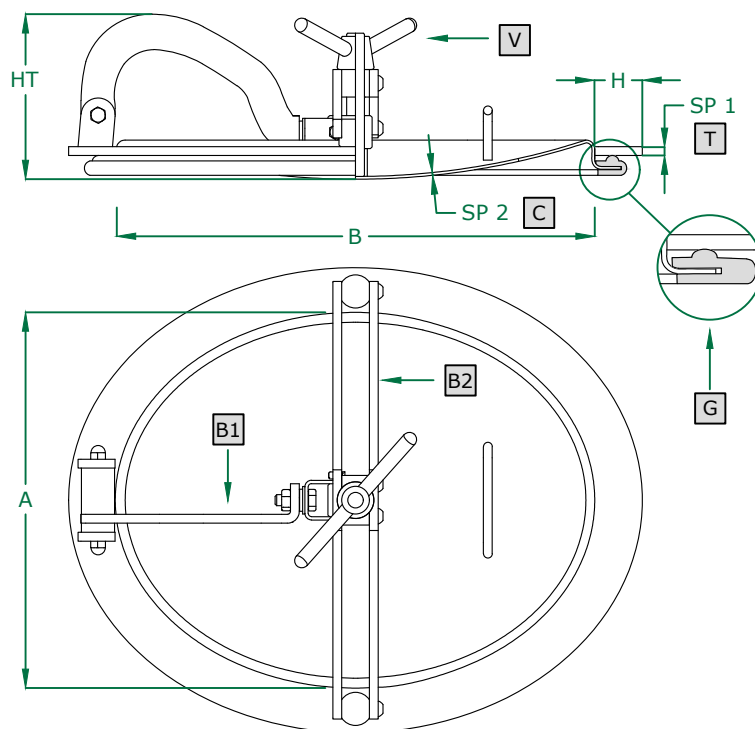



COPERCHIO COVER	C
TELAIO FRAME	T
BRACCIO1 ARM 1	B1
BRACCIO2 ARM 2	B2
VOLANTINO HANDWHEEL	V
GUARNIZIONE GASKET	G



	STANDARD		OPTIONAL			
H X SP1	40 X 8					
TELAIO	SAT		MPL			
GUARNIZIONE	PARA	EPDM	NEOPRENE	NBR	SILICONE	VITON
VOLANTINO	125 034 S. STEEL		125 004 V NYLON			

ART	A	B	SP2	HT (standard)	BAR max: (standard)	COVER type:	GASKET code:	KG (standard)
318	345	445	2,5	170	3,0	CL	120 750	11,0

PORTELLA OVALE apertura interna

-  OVAL Manwaydoor inwards opening
-  Porte OVALE avec ouverture à l'intérieur
-  Puerta OVAL de apertura interna
-  OVALE Mannlochtür schwenkbar nach innen
-  ОВАЛЬНАЯ КРЫШКА с внутренним открытием
-  内开椭圆形人孔门

319 ART
345 X 445 mm
 Rev 0

COPERCHIO COVER	C
TELAIO FRAME	T
BRACCIO ARM	B
VOLANTINO HANDWHEEL	V
GUARNIZIONE GASKET	G

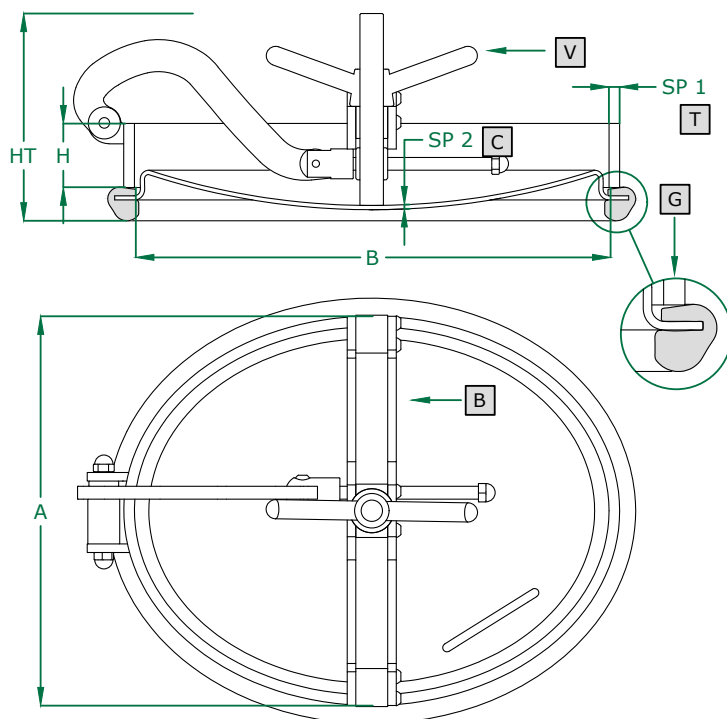







	STANDARD	OPTIONAL			
H X SP1	60 X 10	80 X 10	100 X 10	130 X 10	...
TELAIO	SAT		MPL		
GUARNIZIONE	EPDM	NBR	SILICONE	VITON	
VOLANTINO	125 037 S. STEEL				

ART	A	B	SP2	HT (standard)	BAR max: (standard)	COVER type:	GASKET code:	KG (standard)
319	345	445	4,0	195	5,0	CL	120 622	17,0

320 ART
345 X 445 mm
 Rev 0

PORTELLA OVALE apertura interna

-  OVAL Manwaydoor inwards opening
-  Porte OVALE avec ouverture à l'intérieur
-  Puerta OVAL de apertura interna
-  OVALE Mannlochtür schwenkbar nach innen
-  ОВАЛЬНАЯ КРЫШКА с внутренним открытием
-  内开椭圆形人孔门

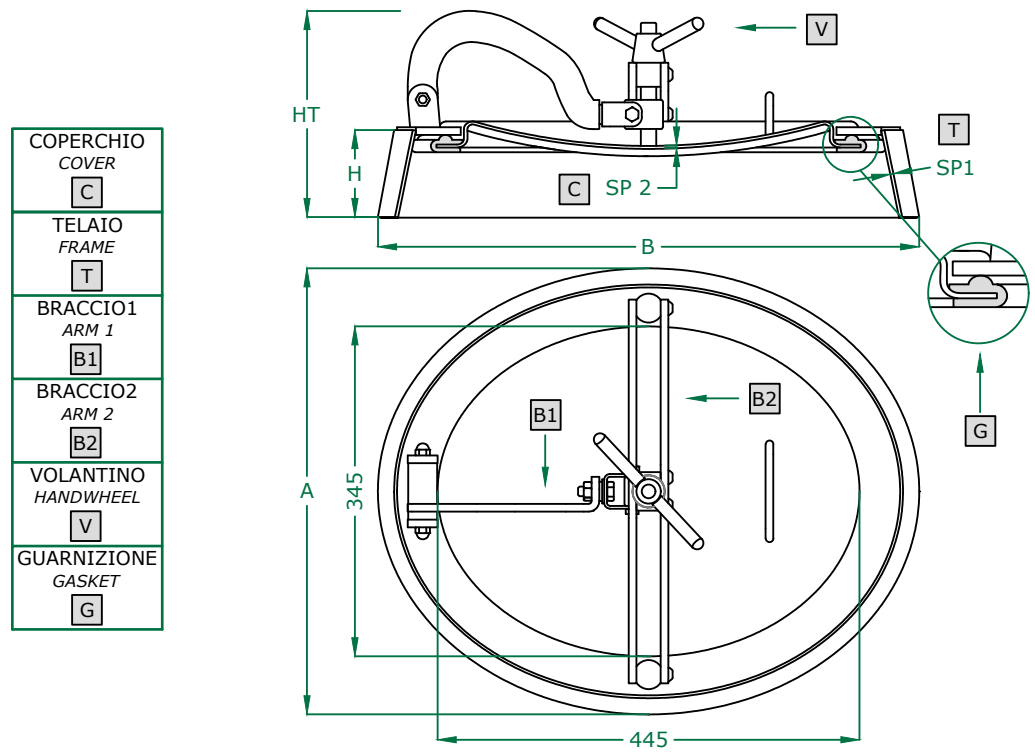

COPERCHIO COVER	C
TELAIO FRAME	T
BRACCIO1 ARM 1	B1
BRACCIO2 ARM 2	B2
VOLANTINO HANDWHEEL	V
GUARNIZIONE GASKET	G

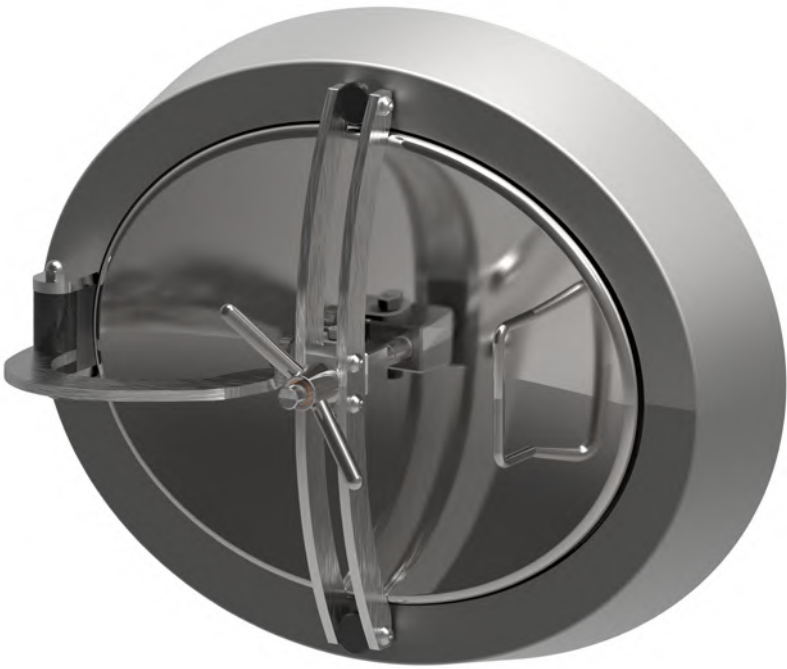







	STANDARD	OPTIONAL				
H X SP1	90 X 3	130 x 3 - RAGGIATURA				
TELAIO	SAT			MPL		
GUARNIZIONE	PARA	EPDM	NEOPRENE	NBR	SILICONE	VITON
VOLANTINO	125 034 S. STEEL M16					

ART	A	B	SP2	HT (standard)	BAR max: (standard)	COVER type:	GASKET code:	KG (standard)
320	460	560	2,5	215	3,0	CL	120 750	14,5
320R	460	560	3,0	215	3,2	CL	120 750	15,5

Le immagini, i dati, i pesi, le caratteristiche tecniche a catalogo non sono impegnative. Ci riserviamo di apportare le modifiche necessarie, senza alcun preavviso. - The images, data, weights and technical specifications are not binding. We reserve the right to make the necessary alterations without prior notice.

PORTELLA OVALE apertura interna

-  OVAL Manwaydoor inwards opening
-  Porte OVALE avec ouverture à l'intérieur
-  Puerta OVAL de apertura interna
-  OVALE Mannlochtür schwenkbar nach innen
-  ОВАЛЬНАЯ КРЫШКА с внутренним открытием
-  内开椭圆形人孔门

321 ART
345 X 445 mm
 Rev 0



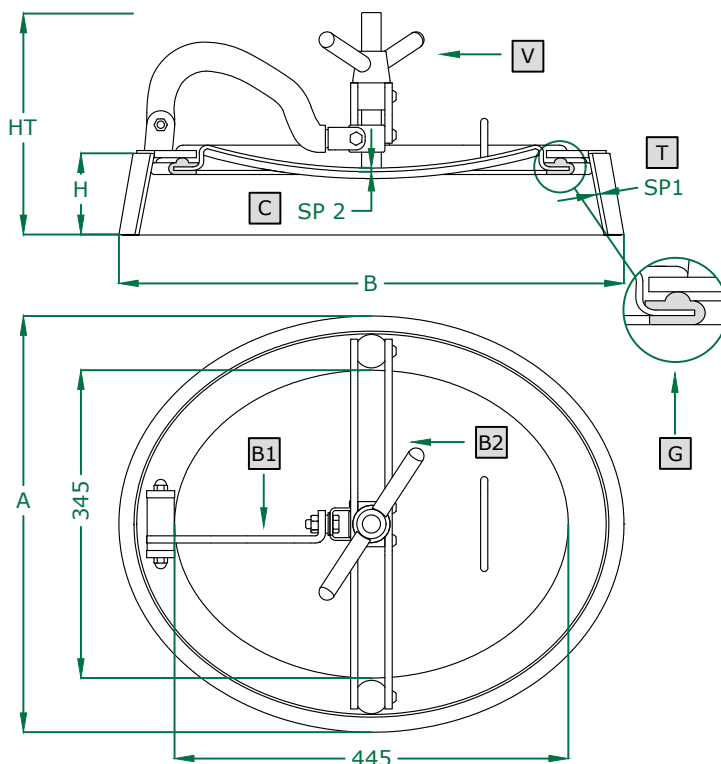



COPERCHIO COVER	C
TELAIO FRAME	T
BRACCIO1 ARM 1	B1
BRACCIO2 ARM 2	B2
VOLANTINO HANDWHEEL	V
GUARNIZIONE GASKET	G



	STANDARD	OPTIONAL				
H X SP1	90 X 4	130 x 4 - RAGGIATURA				
TELAIO	SAT			MPL		
GUARNIZIONE	PARA	EPDM	NEOPRENE	NBR	SILICONE	VITON
VOLANTINO	125 034 S. STEEL M22					

ART	A	B	SP2	HT (standard)	BAR max: (standard)	COVER type:	GASKET code:	KG (standard)
321	460	560	4,0	250	3,5	CL	120 750	18,5

PORTELLA RETTANGOLARE apertura esterna

-  RECTANGULAR manwaydoor outwards opening
-  Porte RECTANGULAIRE avec ouverture à l'extérieur
-  Puerta RECTANGULAR de apertura externa
-  RECHTECKIGE Türchen, Aussenöffnung
-  ПРЯМОУГОЛЬНАЯ КРЫШКА с внешним открытием
-  外开长方形人孔门

362 ART

530 X 400 mm
Rev 0

COPERCHIO COVER	C
TELAIO FRAME	T
BRACCIO ARM	B
VOLANTINO HANDWHEEL	V
GUARNIZIONE GASKET	G

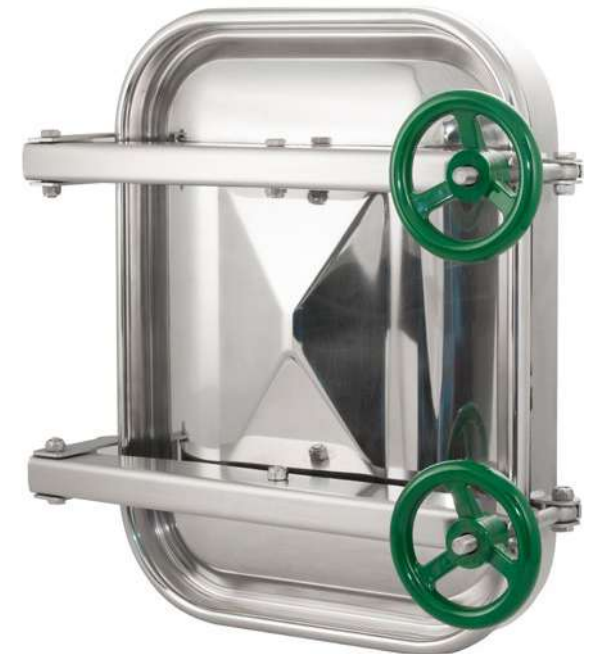
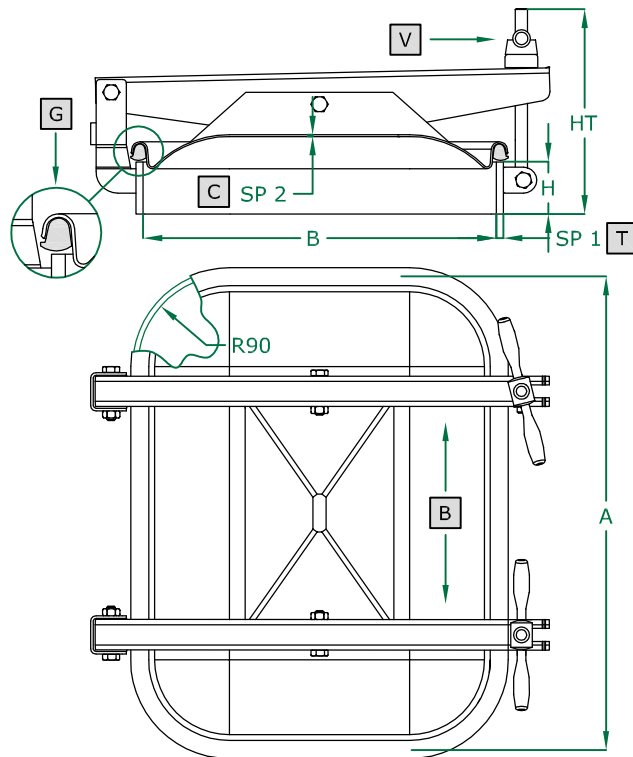

	STANDARD		OPTIONAL			
H X SP1	60 X 8	80 X 8	100 X 8			
TELAIO	SAT		MPL			
GUARNIZIONE	PARA	EPDM	NEOPRENE	NBR	SILICONE	VITON
VOLANTINO	125 011 V NYLON		125 033 S. STEEL			

ART	A	B	SP2	HT (standard)	BAR max: (standard)	COVER type:	GASKET code:	KG (standard)
362	530	400	2	215	1,0	CL	120 607	18,52







AISI 304 - 316L

362V ART

530 X 400 mm

Rev 0

PORTELLA RETTANGOLARE apertura esterna

-  RECTANGULAR manwaydoor outwards opening
-  Porte RECTANGULAIRE avec ouverture à l'extérieur
-  Puerta RECTANGULAR de apertura externa
-  RECHTECKIGE Türchen, Aussenöffnung
-  ПРЯМОУГОЛЬНАЯ КРЫШКА с внешним открытием
-  外开长方形人孔门



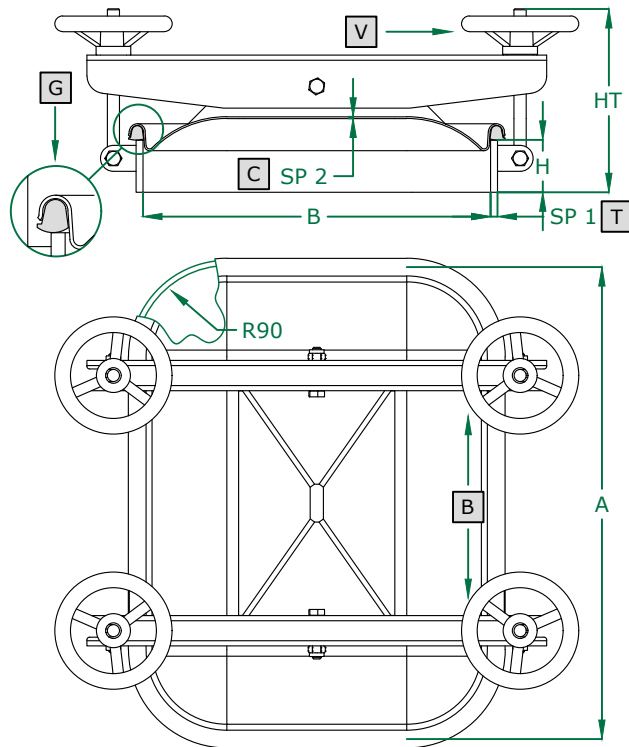



COPERCHIO COVER	C
TELAIO FRAME	T
BRACCIO ARM	B
VOLANTINO HANDWHEEL	V
GUARNIZIONE GASKET	G



	STANDARD		OPTIONAL			
H X SP1	60 X 8	80 X 8	100 X 8			
TELAIO	SAT		MPL			
GUARNIZIONE	PARA	EPDM	NEOPRENE	NBR	SILICONE	VITON
VOLANTINO	125 011 V NYLON		125 033 S. STEEL			

ART	A	B	SP2	HT (standard)	BAR max: (standard)	COVER type:	GASKET code:	KG (standard)
362	530	400	2	215	1,0	CL	120 607	18,52

PORTELLA RETTANGOLARE apertura esterna

-  RECTANGULAR manwaydoor outwards opening
-  Porte RECTANGULAIRE avec ouverture à l'extérieur
-  Puerta RECTANGULAR de apertura externa
-  RECHTECKIGE Türchen, Aussenöffnung
-  ПРЯМОУГОЛЬНАЯ КРЫШКА с внешним открытием
-  外开长方形人孔门

362R ART

530 X 400 mm
Rev 0



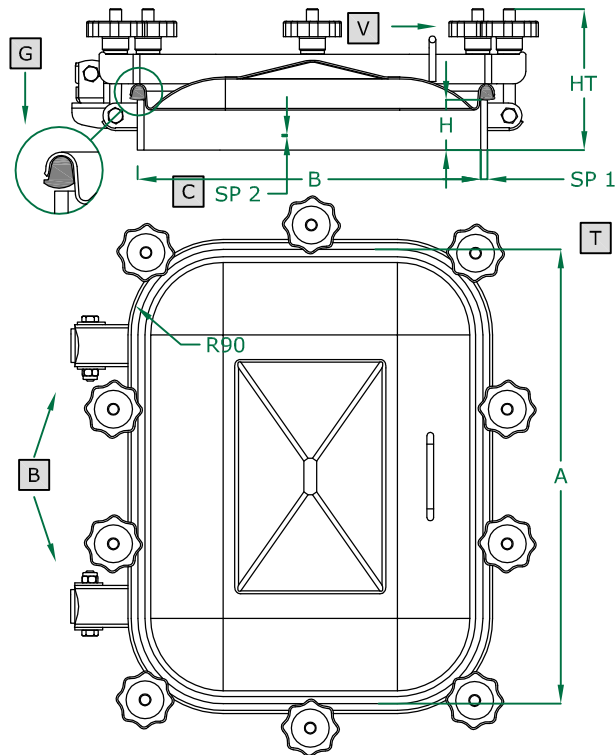



COPERCHIO COVER	C
TELAIO FRAME	T
BRACCIO ARM	B
VOLANTINO HANDWHEEL	V
GUARNIZIONE GASKET	G



	STANDARD		OPTIONAL			
H X SP1	60 X 8	80 X 8	100 X 8			
TELAIO	SAT		MPL			
GUARNIZIONE	PARA	EPDM	NEOPRENE	NBR	SILICONE	VITON
VOLANTINO	125 003 V NYLON		125 033 S. STEEL			

ART	A	B	SP2	HT (standard)	BAR max: (standard)	COVER type:	GASKET code:	KG (standard)
362R	530	400	2	215	2,5	CL	120 607	20,0

PORTELLA RETTANGOLARE apertura esterna

-  RECTANGULAR manwaydoor outwards opening
-  Porte RECTANGULAIRE avec ouverture à l'extérieur
-  Puerta RECTANGULAR de apertura externa
-  RECHTECKIGE Türchen, Aussenöffnung
-  ПРЯМОУГОЛЬНАЯ КРЫШКА с внешним открытием
-  外开长方形人孔门

363 ART
400 X 530 mm
Rev 0

COPERCHIO COVER	C
TELAIO FRAME	T
BRACCIO ARM	B
VOLANTINO HANDWHEEL	V
GUARNIZIONE GASKET	G

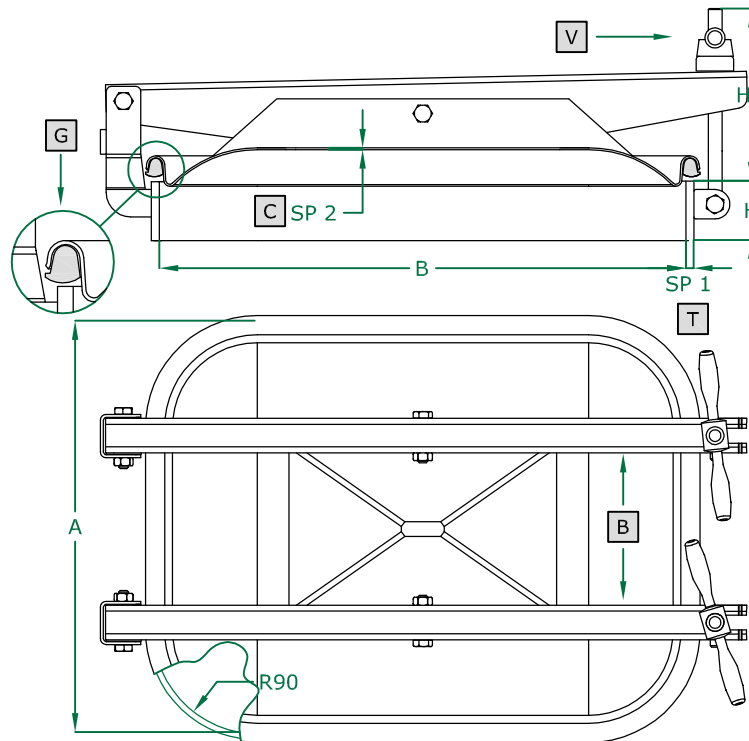







	STANDARD		OPTIONAL			
H X SP1	60 X 8	100 X 8	...			
TELAIO	SAT		MPL			
GUARNIZIONE	PARA	EPDM	NEOPRENE	NBR	SILICONE	VITON
VOLANTINO	125 011 V NYLON			125 033 S. STEEL		

ART	A	B	SP2	HT (standard)	BAR max: (standard)	COVER type:	GASKET code:	KG (standard)
363	400	530	2	225	1,0	CL	120 607	18,7

AISI 304 - 316L

363V ART
400 X 530 mm
Rev 0

PORTELLA RETTANGOLARE apertura esterna

-  RECTANGULAR manwaydoor outwards opening
-  Porte RECTANGULAIRE avec ouverture à l'extérieur
-  Puerta RECTANGULAR de apertura externa
-  RECHTECKIGE Türchen, Aussenöffnung
-  ПРЯМОУГОЛЬНАЯ КРЫШКА с внешним открытием
-  外开长方形人孔门



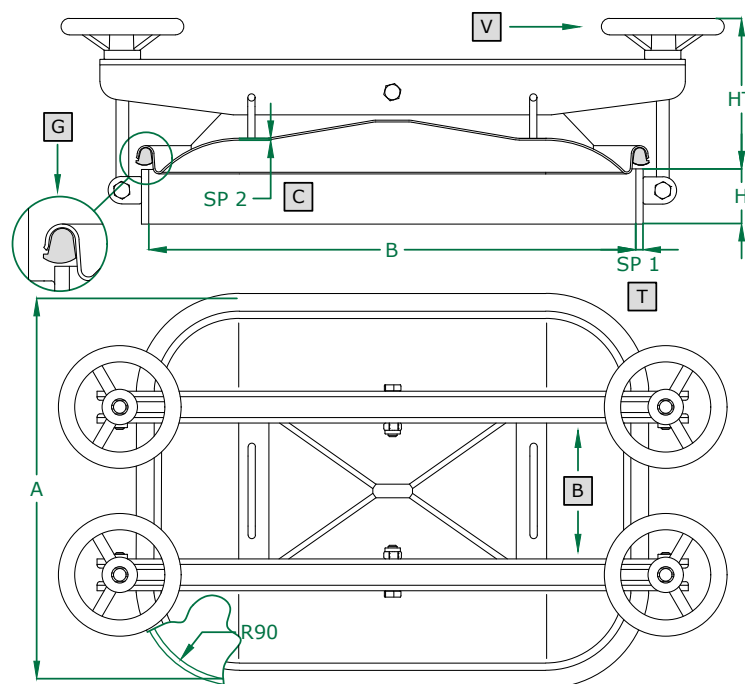



COPERCHIO COVER	C
TELAIO FRAME	T
BRACCIO ARM	B
VOLANTINO HANDWHEEL	V
GUARNIZIONE GASKET	G



	STANDARD		OPTIONAL			
H X SP1	60 X 8	100 X 8	...			
TELAIO	SAT			MPL		
GUARNIZIONE	PARA	EPDM	NEOPRENE	NBR	SILICONE	VITON
VOLANTINO	125 011 V NYLON			125 033 S. STEEL		

ART	A	B	SP2	HT (standard)	BAR max: (standard)	COVER type:	GASKET code:	KG (standard)
363B	400	530	2	225	0,3	CL	120 607	16,5

PORTELLA RETTANGOLARE apertura esterna

-  RECTANGULAR manwaydoor outwards opening
-  Porte RECTANGULAIRE avec ouverture à l'extérieur
-  Puerta RECTANGULAR de apertura externa
-  RECHTECKIGE Türchen, Aussenöffnung
-  ПРЯМОУГОЛЬНАЯ КРЫШКА с внешним открытием
-  外开长方形人孔门

363R ART

400 X 530 mm
Rev 0



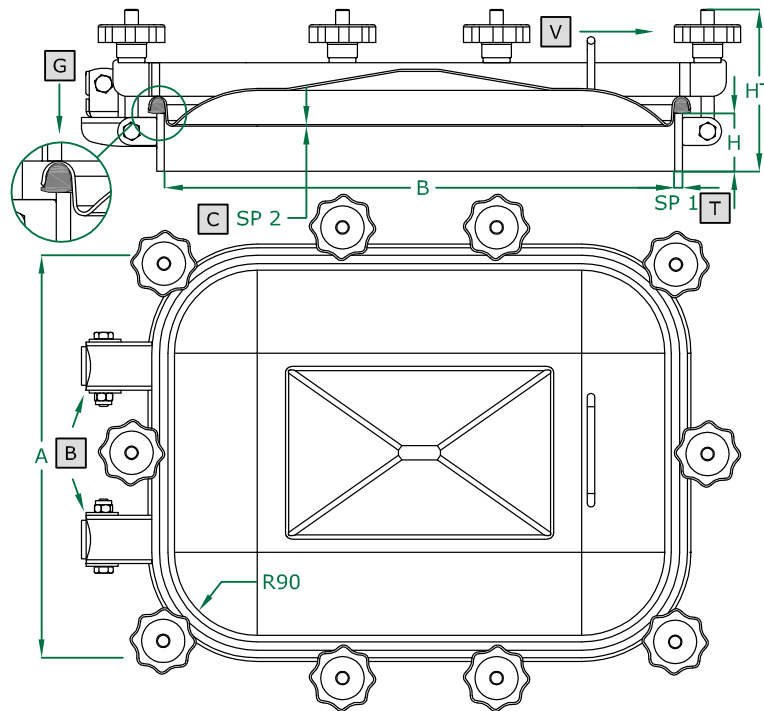



COPERCHIO COVER	C
TELAIO FRAME	T
BRACCIO ARM	B
VOLANTINO HANDWHEEL	V
GUARNIZIONE GASKET	G



	STANDARD		OPTIONAL			
H X SP1	60 X 8	100 X 8	...			
TELAIO	SAT		MPL			
GUARNIZIONE	PARA	EPDM	NEOPRENE	NBR	SILICONE	VITON
VOLANTINO	125 003 V NYLON		125 033 S. STEEL			

ART	A	B	SP2	HT (standard)	BAR max: (standard)	COVER type:	GASKET code:	KG (standard)
363R	400	530	2	225	2,5	CL	120 607	20,0

PORTELLA RETTANGOLARE apertura esterna

-  RECTANGULAR manwaydoor outwards opening
-  Porte RECTANGULAIRE avec ouverture à l'extérieur
-  Puerta RECTANGULAR de apertura externa
-  RECHTECKIGE Türchen, Aussenöffnung
-  ПРЯМОУГОЛЬНАЯ КРЫШКА с внешним открытием
-  外开长方形人孔门

363B ART

400 X 530 mm
Rev 0

COPERCHIO COVER	C
TELAIO FRAME	T
BRACCIO ARM	B
VOLANTINO HANDWHEEL	V
GUARNIZIONE GASKET	G

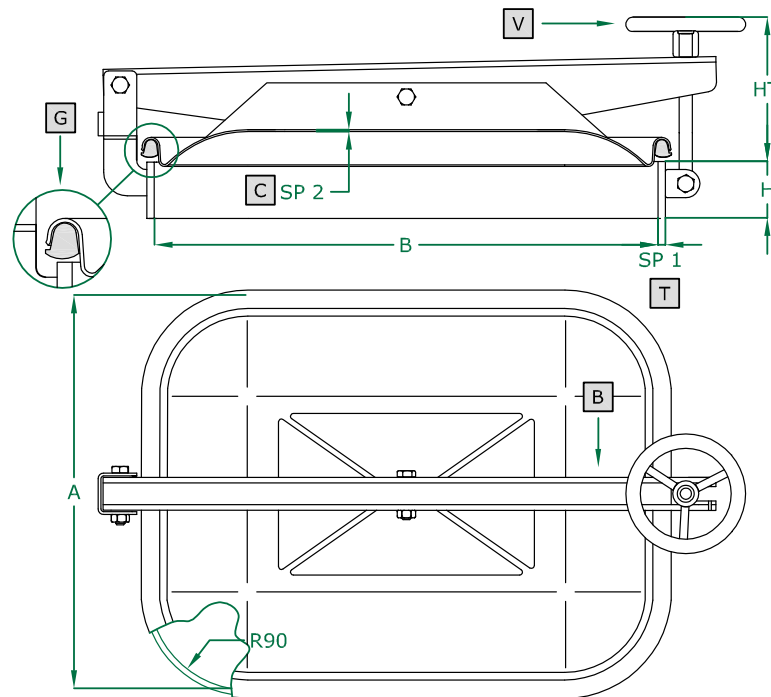







	STANDARD		OPTIONAL			
H X SP1	60 X 8	100 X 8	...			
TELAIO	SAT		MPL			
GUARNIZIONE	PARA	EPDM	NEOPRENE	NBR	SILICONE	VITON
VOLANTINO	125 011 V NYLON		125 033 S. STEEL			

ART	A	B	SP2	HT (standard)	BAR max: (standard)	COVER type:	GASKET code:	KG (standard)
363B	400	530	2	225	0,3	CL	120 607	16,5

363BV ART

400 X 530 mm
Rev 0

PORTELLA RETTANGOLARE apertura esterna

-  RECTANGULAR manwaydoor outwards opening
-  Porte RECTANGULAIRE avec ouverture à l'extérieur
-  Puerta RECTANGULAR de apertura externa
-  RECHTECKIGE Türchen, Aussenöffnung
-  ПРЯМОУГОЛЬНАЯ КРЫШКА с внешним открытием
-  外开长方形人孔门



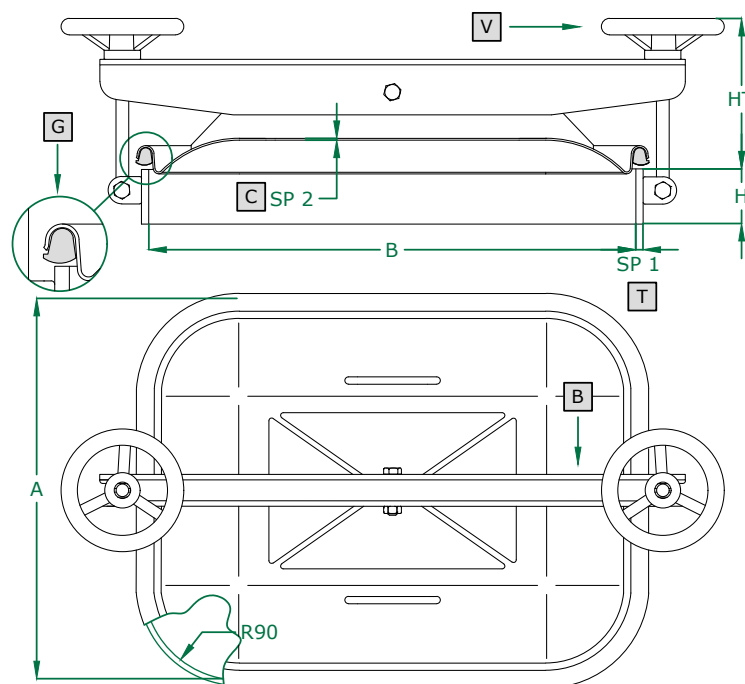



COPERCHIO COVER	C
TELAIO FRAME	T
BRACCIO ARM	B
VOLANTINO HANDWHEEL	V
GUARNIZIONE GASKET	G



	STANDARD		OPTIONAL			
H X SP1	60 X 8	100 X 8	...			
TELAIO	SAT			MPL		
GUARNIZIONE	PARA	EPDM	NEOPRENE	NBR	SILICONE	VITON
VOLANTINO	125 011 V NYLON			125 033 S. STEEL		

ART	A	B	SP2	HT (standard)	BAR max: (standard)	COVER type:	GASKET code:	KG (standard)
363B	400	530	2	225	0,3	CL	120 607	16,5

PORTELLA RETTANGOLARE apertura interna

-  RECTANGULAR manwaydoor inwards opening
-  Porte RECTANGULAIRE avec ouverture à l'intérieur
-  Puerta RECTANGULAR de apertura interna
-  RECHTECKIGE Türchen, Innenöffnung
-  ПРЯМОУГОЛЬНАЯ КРЫШКА с внутренним открытием
-  内开长方形人孔门

364 ART
530 X 400 mm
Rev 0



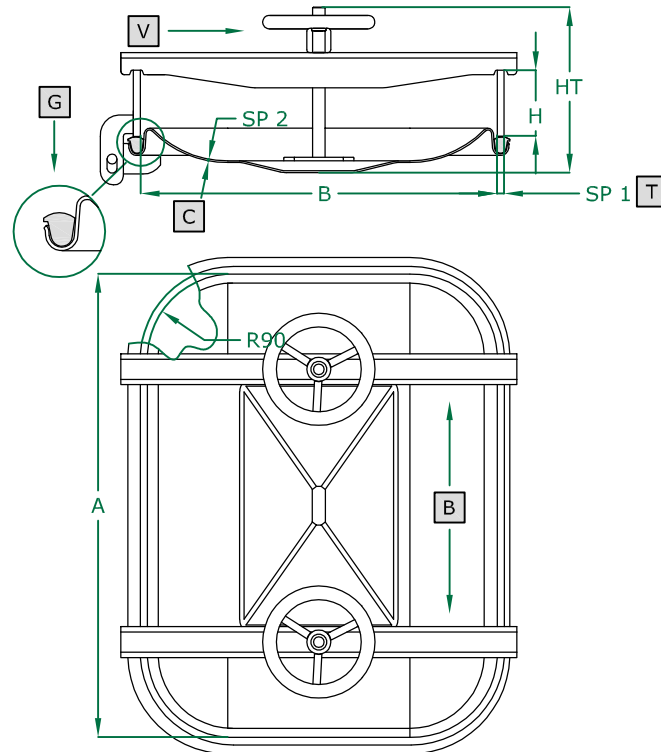



COPERCHIO COVER	C
TELAIO FRAME	T
BRACCIO ARM	B
VOLANTINO HANDWHEEL	V
GUARNIZIONE GASKET	G



	STANDARD		OPTIONAL			
H X SP1	60 X 8	100 X 8				...
TELAIO	SAT			MPL		
GUARNIZIONE	PARA	EPDM	NEOPRENE	NBR	SILICONE	VITON
VOLANTINO	125 004 V NYLON			125 034 S. STEEL		

ART	A	B	SP2	HT (standard)	BAR max: (standard)	COVER type:	GASKET code:	KG (standard)
364	530	400	2	150	1,0	CL	120 607	16,0

PORTELLA RETTANGOLARE apertura esterna

-  RECTANGULAR manwaydoor outwards opening
-  Porte RECTANGULAIRE avec ouverture à l'extérieur
-  Puerta RECTANGULAR de apertura externa
-  RECHTECKIGE Türchen, Aussenöffnung
-  ПРЯМОУГОЛЬНАЯ КРЫШКА с внешним открытием
-  外开长方形人孔门

372 ART
420 X 310 mm
Rev 0



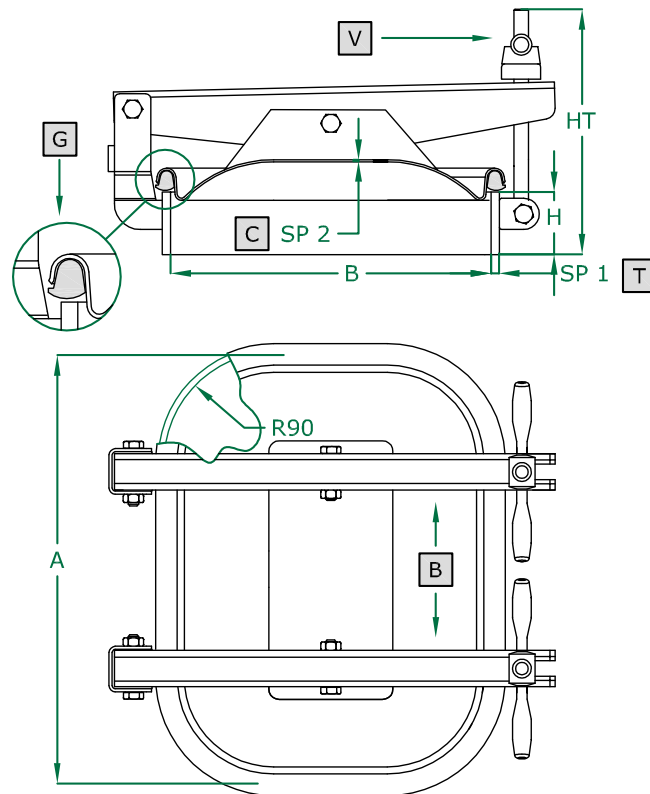



COPERCHIO COVER	C
TELAIO FRAME	T
BRACCIO ARM	B
VOLANTINO HANDWHEEL	V
GUARNIZIONE GASKET	G



	STANDARD		OPTIONAL			
H X SP1	60 X 8	100 X 8				...
TELAIO	SAT			MPL		
GUARNIZIONE	PARA	EPDM	NEOPRENE	NBR	SILICONE	VITON
VOLANTINO	125 011 V NYLON		125 033 S. STEEL		125 003 V NYLON	

ART	A	B	SP2	HT (standard)	BAR max: (standard)	COVER type:	GASKET code:	KG (standard)
372	422	312	2	215	0,8	CL	120 620	14

PORTELLA RETTANGOLARE apertura esterna

-  RECTANGULAR manwaydoor outwards opening
-  Porte RECTANGULAIRE avec ouverture à l'extérieur
-  Puerta RECTANGULAR de apertura externa
-  RECHTECKIGE Türchen, Aussenöffnung
-  ПРЯМОУГОЛЬНАЯ КРЫШКА с внешним открытием
-  外开长方形人孔门



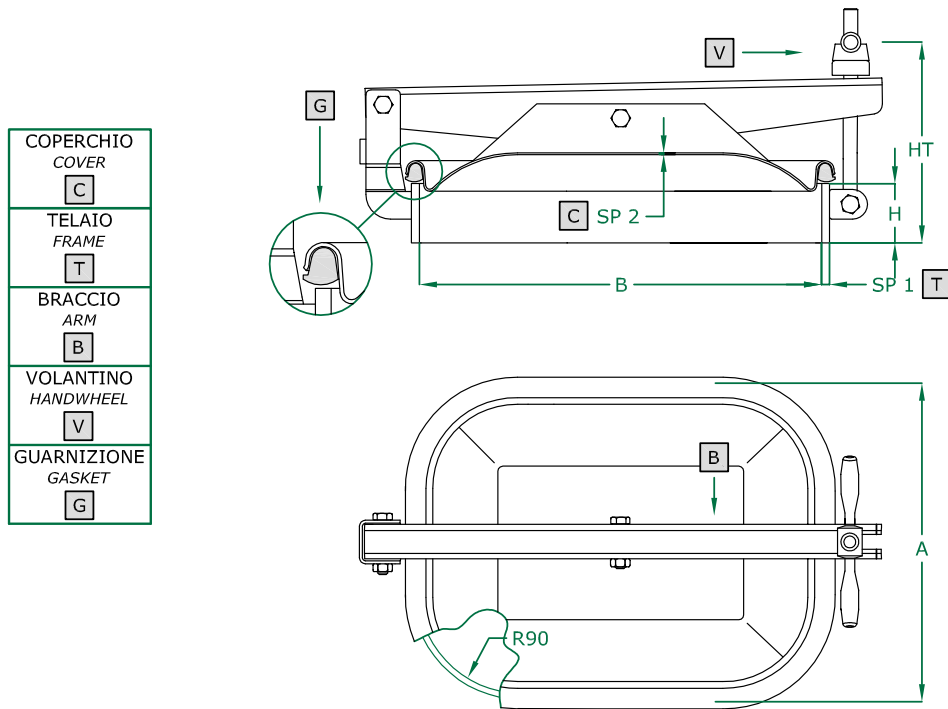



373 ART
310 X 420 mm
Rev 0



	STANDARD		OPTIONAL			
H X SP1	60 X 8	100 X 8				...
TELAIO	SAT			MPL		
GUARNIZIONE	PARA	EPDM	NEOPRENE	NBR	SILICONE	VITON
VOLANTINO	125 011 V NYLON		125 033 S. STEEL		125 003 V NYLON	

ART	A	B	SP2	HT (standard)	BAR max: (standard)	COVER type:	GASKET code:	KG (standard)
373	312	422	2	215	0,8	CL	120 620	12,5

PORTELLA RETTANGOLARE apertura interna

-  RECTANGULAR manwaydoor inwards opening
-  Porte RECTANGULAIRE avec ouverture à l'intérieur
-  Puerta RECTANGULAR de apertura interna
-  RECHTECKIGE Türchen, Innenöffnung
-  ПРЯМОУГОЛЬНАЯ КРЫШКА с внутренним открытием
-  内开长方形人孔门

374 ART
420 X 310 mm
Rev 0



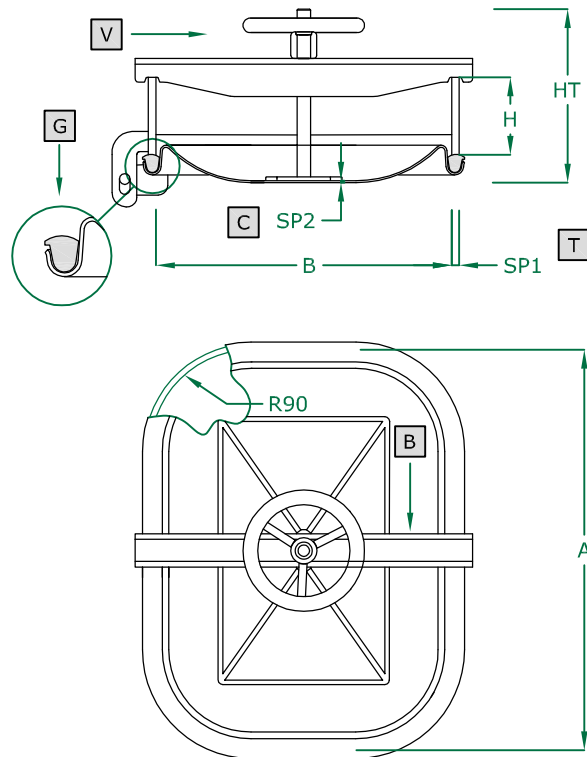



COPERCHIO COVER	C
TELAIO FRAME	T
BRACCIO ARM	B
VOLANTINO HANDWHEEL	V
GUARNIZIONE GASKET	G



	STANDARD		OPTIONAL			
H X SP1	60 X 8	100 X 8				...
TELAIO	SAT			MPL		
GUARNIZIONE	PARA	EPDM	NEOPRENE	NBR	SILICONE	VITON
VOLANTINO	125 004 V NYLON			125 034 S. STEEL		

ART	A	B	SP2	HT (standard)	BAR max: (standard)	COVER type:	GASKET code:	KG (standard)
374	422	312	2	205	1,0	CL	120 620	10

PORTELLA RETTANGOLARE apertura esterna

-  RECTANGULAR manwaydoor outwards opening
-  Porte RECTANGULAIRE avec ouverture à l'extérieur
-  Puerta RECTANGULAR de apertura externa
-  RECHTECKIGE Türchen, Aussenöffnung
-  ПРЯМОУГОЛЬНАЯ КРЫШКА с внешним открытием
-  外开长方形人孔门

375 ART
420 X 310 mm
Rev 0



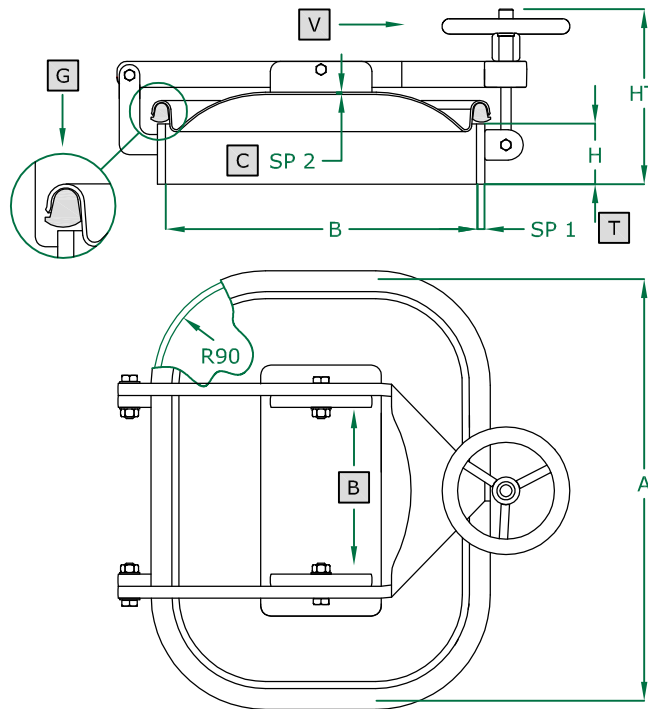



COPERCHIO COVER	C
TELAIO FRAME	T
BRACCIO ARM	B
VOLANTINO HANDWHEEL	V
GUARNIZIONE GASKET	G



	STANDARD		OPTIONAL			
H X SP1	60 X 8	100 X 8	...			
TELAIO	SAT		MPL			
GUARNIZIONE	PARA	EPDM	NEOPRENE	NBR	SILICONE	VITON
VOLANTINO	125 011 V NYLON		125 033 S. STEEL		125 003 V NYLON	

ART	A	B	SP2	HT (standard)	BAR max: (standard)	COVER type:	GASKET code:	KG (standard)
375	422	312	2	215	0,8	CL	120 620	12,5

PORTELLA RETTANGOLARE apertura esterna

-  RECTANGULAR manwaydoor outwards opening
-  Porte RECTANGULAIRE avec ouverture à l'extérieur
-  Puerta RECTANGULAR de apertura externa
-  RECHTECKIGE Türchen, Aussenöffnung
-  ПРЯМОУГОЛЬНАЯ КРЫШКА с внешним открытием
-  外开长方形人孔门

376 ART
310 X 420 mm
Rev 0



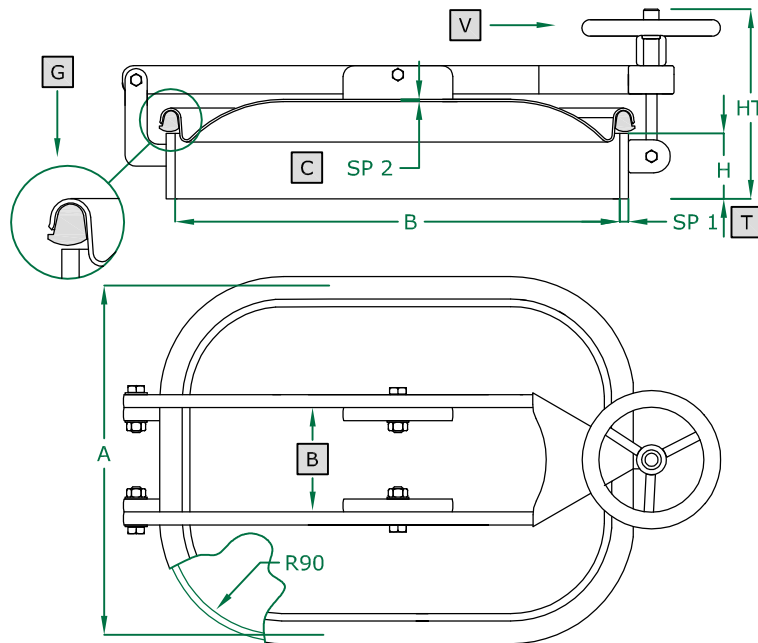



COPERCHIO COVER	C
TELAIO FRAME	T
BRACCIO ARM	B
VOLANTINO HANDWHEEL	V
GUARNIZIONE GASKET	G



	STANDARD		OPTIONAL			
H X SP1	60 X 8	100 X 8	...			
TELAIO	SAT	MPL				
GUARNIZIONE	PARA	EPDM	NEOPRENE	NBR	SILICONE	VITON
VOLANTINO	125 011 V NYLON	125 033 S. STEEL		125 003 V NYLON		

ART	A	B	SP2	HT (standard)	BAR max: (standard)	COVER type:	GASKET code:	KG (standard)
376	312	422	2	215	0,8	CL	120 620	12,0

PORTELLA RETTANGOLARE apertura esterna

-  RECTANGULAR manwaydoor outwards opening
-  Porte RECTANGULAIRE avec ouverture à l'extérieur
-  Puerta RECTANGULAR de apertura externa
-  RECHTECKIGE Türchen, Aussenöffnung
-  ПРЯМОУГОЛЬНАЯ КРЫШКА с внешним открытием
-  外开长方形人孔门

381 ART
225 X 175 mm
Rev 0



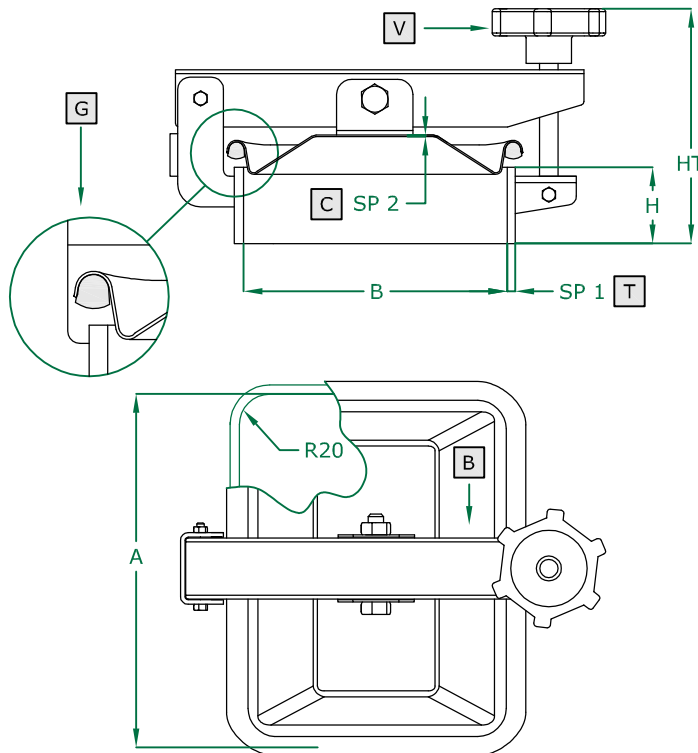



COPERCHIO COVER	C
TELAIO FRAME	T
BRACCIO ARM	B
VOLANTINO HANDWHEEL	V
GUARNIZIONE GASKET	G



	STANDARD		OPTIONAL			
H X SP1	50 X 6		30 X 6		100 X 6	
TELAIO	SAT		MPL			
GUARNIZIONE	EPDM	NEOPRENE	NBR	SILICONE	VITON	
VOLANTINO	125 001 V NYLON	125 021 V NYLON	125 022 CHROME P.	125 023 S. STEEL	125 024 ALUMINIUM	125 031 S. STEEL

ART	A	B	SP2	HT (standard)	BAR max: (standard)	COVER type:	GASKET code:	KG (standard)
381	223	174	1	130	0,7	CN	120 613	4,0

PORTELLA RETTANGOLARE apertura esterna

-  RECTANGULAR manwaydoor outwards opening
-  Porte RECTANGULAIRE avec ouverture à l'extérieur
-  Puerta RECTANGULAR de apertura externa
-  RECHTECKIGE Türchen, Aussenöffnung
-  ПРЯМОУГОЛЬНАЯ КРЫШКА с внешним открытием
-  外开长方形人孔门

381L ART

175 X 225 mm
Rev 0



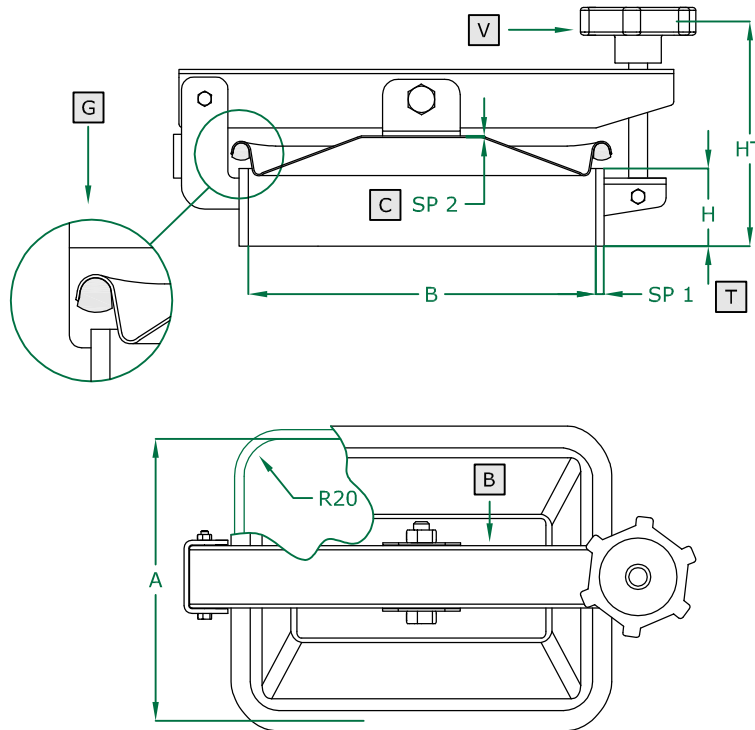



COPERCHIO COVER	C
TELAIO FRAME	T
BRACCIO ARM	B
VOLANTINO HANDWHEEL	V
GUARNIZIONE GASKET	G



	STANDARD		OPTIONAL			
H X SP1	50 X 6	30 X 6			100 X 6	
TELAIO	SAT		MPL			
GUARNIZIONE	EPDM	NEOPRENE	NBR	SILICONE	VITON	
VOLANTINO	125 001 V NYLON	125 021 V NYLON	125 022 CHROME P.	125 023 S. STEEL	125 024 ALUMINIUM	125 031 S. STEEL

ART	A	B	SP2	HT (standard)	BAR max: (standard)	COVER type:	GASKET code:	KG (standard)
381L	174	223	1	130	0,7	CN	120 613	4,0

PORTELLA RETTANGOLARE apertura esterna

-  RECTANGULAR manwaydoor outwards opening
-  Porte RECTANGULAIRE avec ouverture à l'extérieur
-  Puerta RECTANGULAR de apertura externa
-  RECHTECKIGE Türchen, Aussenöffnung
-  ПРЯМОУГОЛЬНАЯ КРЫШКА с внешним открытием
-  外开长方形人孔门

382 ART
310 X 245 mm
Rev 0



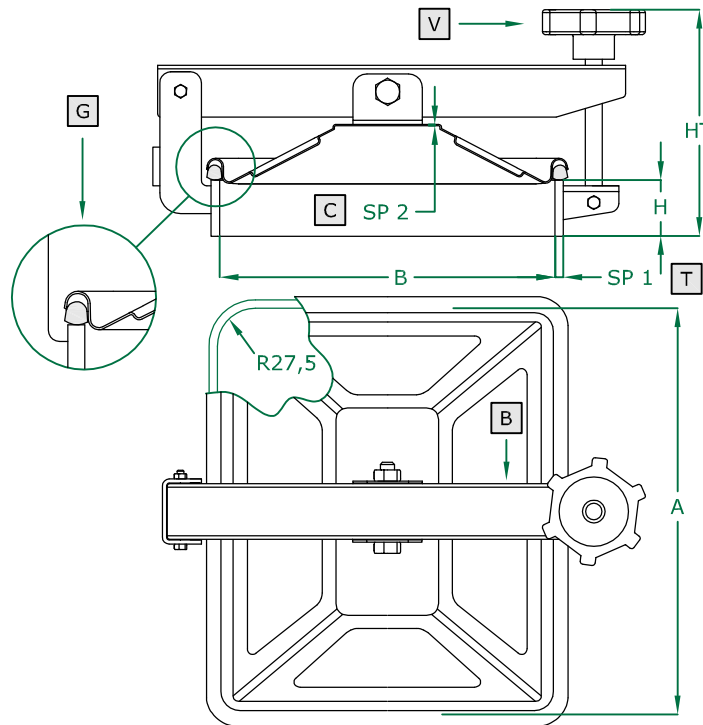



COPERCHIO COVER	C
TELAIO FRAME	T
BRACCIO ARM	B
VOLANTINO HANDWHEEL	V
GUARNIZIONE GASKET	G



	STANDARD		OPTIONAL			
H X SP1	50 X 6		30 X 6		100 X 6	
TELAIO	SAT		MPL			
GUARNIZIONE	PARA	EPDM	NEOPRENE	NBR	SILICONE	VITON
VOLANTINO	125 001 V NYLON	125 021 V NYLON	125 022 CHROME P.	125 023 S. STEEL	125 024 ALUMINIUM	125 031 S. STEEL

ART	A	B	SP2	HT (standard)	BAR max: (standard)	COVER type:	GASKET code:	KG (standard)
382	312	245	1,0	145	0,5	CN	120 615	6,0

PORTELLA RETTANGOLARE apertura esterna

-  RECTANGULAR manwaydoor outwards opening
-  Porte RECTANGULAIRE avec ouverture à l'extérieur
-  Puerta RECTANGULAR de apertura externa
-  RECHTECKIGE Türchen, Aussenöffnung
-  ПРЯМОУГОЛЬНАЯ КРЫШКА с внешним открытием
-  外开长方形人孔门

382L ART

245 X 310 mm
Rev 0



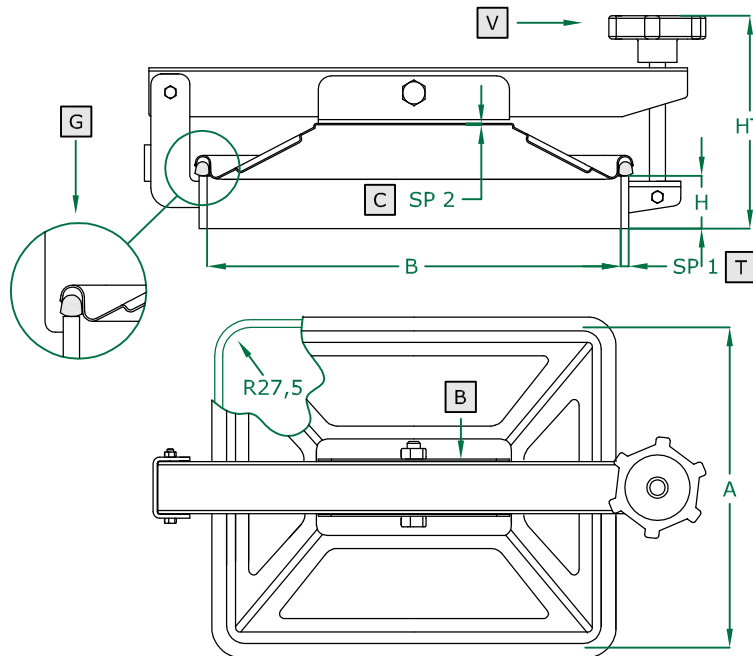



COPERCHIO COVER	C
TELAIO FRAME	T
BRACCIO ARM	B
VOLANTINO HANDWHEEL	V
GUARNIZIONE GASKET	G



	STANDARD		OPTIONAL			
H X SP1	50 X 6		30 X 6		100 X 6	
TELAIO	SAT		MPL			
GUARNIZIONE	PARA	EPDM	NEOPRENE	NBR	SILICONE	VITON
VOLANTINO	125 001 V NYLON	125 021 V NYLON	125 022 CHROME P.	125 023 S. STEEL	125 024 ALUMINIUM	125 031 S. STEEL

ART	A	B	SP2	HT (standard)	BAR max: (standard)	COVER type:	GASKET code:	KG (standard)
382L	245	312	1,0	145	0,5	CN	120 615	5,5

PORTELLA RETTANGOLARE apertura esterna

-  RECTANGULAR manwaydoor outwards opening
-  Porte RECTANGULAIRE avec ouverture à l'extérieur
-  Puerta RECTANGULAR de apertura externa
-  RECHTECKIGE Türchen, Aussenöffnung
-  ПРЯМОУГОЛЬНАЯ КРЫШКА с внешним открытием
-  外开长方形人孔门

383 ART
365 x 275 mm
Rev 1



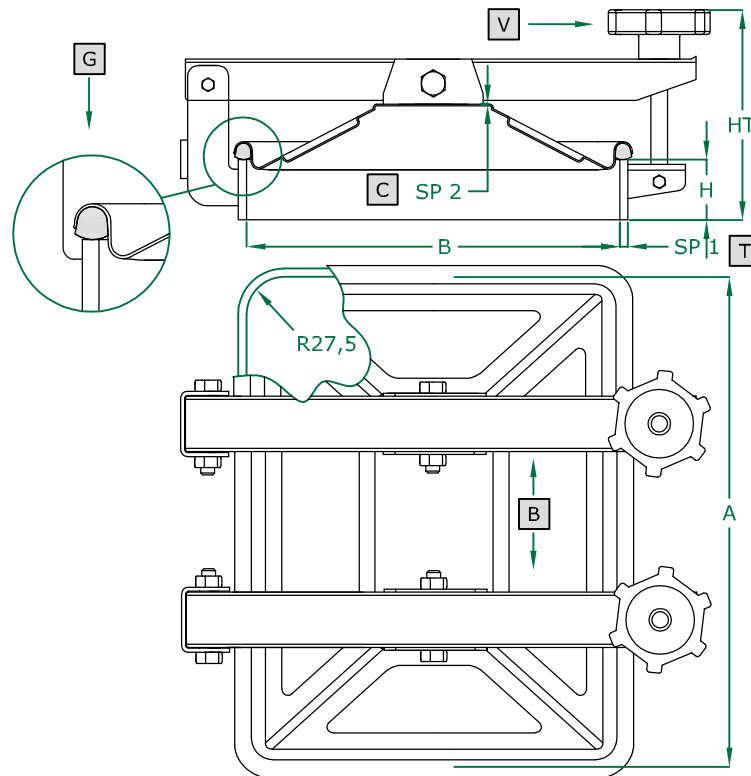



COPERCHIO COVER	C
TELAIO FRAME	T
BRACCIO ARM	B
VOLANTINO HANDWHEEL	V
GUARNIZIONE GASKET	G



	STANDARD		OPTIONAL			
H X SP1	50 X 6		100 X 6			
TELAIO	SAT		MPL			
GUARNIZIONE	PARA	EPDM	NEOPRENE	NBR	SILICONE	VITON
VOLANTINO	125 001 V NYLON	125 021 V NYLON	125 022 CHROME P.	125 023 S. STEEL	125 024 ALUMINIUM	125 031 S. STEEL

ART	A	B	SP2	HT (standard)	BAR max: (standard)	COVER type:	GASKET code:	KG (standard)
383	365	275	1,0	170	0,4	CN	120 617	7,25

PORTELLA RETTANGOLARE apertura esterna

-  RECTANGULAR manwaydoor outwards opening
-  Porte RECTANGULAIRE avec ouverture à l'extérieur
-  Puerta RECTANGULAR de apertura externa
-  RECHTECKIGE Türchen, Aussenöffnung
-  ПРЯМОУГОЛЬНАЯ КРЫШКА с внешним открытием
-  外开长方形人孔门

383L ART

275 x 365 mm
Rev 1



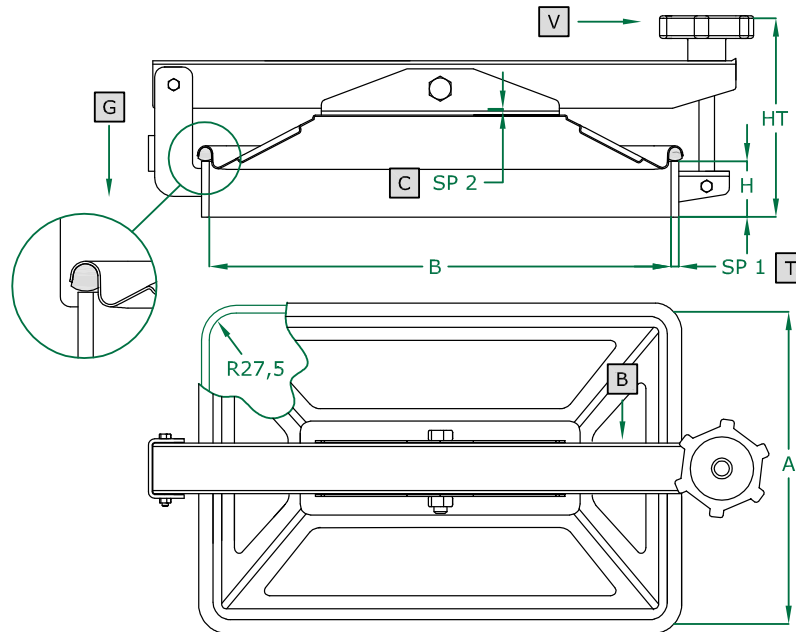



COPERCHIO COVER	C
TELAIO FRAME	T
BRACCIO ARM	B
VOLANTINO HANDWHEEL	V
GUARNIZIONE GASKET	G



	STANDARD		OPTIONAL			
H X SP1	50 X 6		100 X 6			
TELAIO	SAT		MPL			
GUARNIZIONE	PARA	EPDM	NEOPRENE	NBR	SILICONE	VITON
VOLANTINO	125 001 V NYLON	125 021 V NYLON	125 022 CHROME P.	125 023 S. STEEL	125 024 ALUMINIUM	125 031 S. STEEL

ART	A	B	SP2	HT (standard)	BAR max: (standard)	COVER type:	GASKET code:	KG (standard)
383L	275	365	1,0	175	0,3	CN	120 617	6,0

PORTELLA RETTANGOLARE apertura esterna

-  RECTANGULAR manwaydoor outwards opening
-  Porte RECTANGULAIRE avec ouverture à l'extérieur
-  Puerta RECTANGULAR de apertura externa
-  RECHTECKIGE Türchen, Aussenöffnung
-  ПРЯМОУГОЛЬНАЯ КРЫШКА с внешним открытием
-  外开长方形人孔门

384 ART

405 x 275 mm
Rev 1



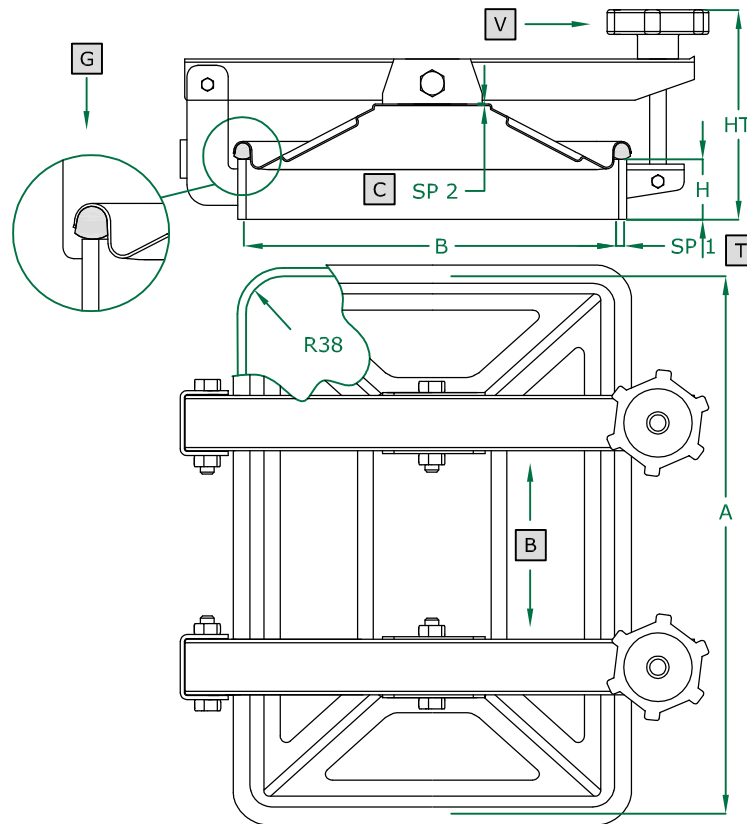



COPERCHIO COVER	C
TELAIO FRAME	T
BRACCIO ARM	B
VOLANTINO HANDWHEEL	V
GUARNIZIONE GASKET	G



	STANDARD		OPTIONAL			
H X SP1	50 X 6		100 X 6			
TELAIO	SAT		MPL			
GUARNIZIONE	PARA	EPDM	NEOPRENE	NBR	SILICONE	VITON
VOLANTINO	125 001 V NYLON	125 021 V NYLON	125 022 CHROME P.	125 023 S. STEEL	125 024 ALUMINIUM	125 031 S. STEEL

ART	A	B	SP2	HT (standard)	BAR max: (standard)	COVER type:	GASKET code:	KG (standard)
384	405	275	1,0	170	0,4	CN	120 617	8,0

PORTELLA RETTANGOLARE apertura esterna

-  RECTANGULAR manwaydoor outwards opening
-  Porte RECTANGULAIRE avec ouverture à l'extérieur
-  Puerta RECTANGULAR de apertura externa
-  RECHTECKIGE Türchen, Aussenöffnung
-  ПРЯМОУГОЛЬНАЯ КРЫШКА с внешним открытием
-  外开长方形人孔门

384L ART



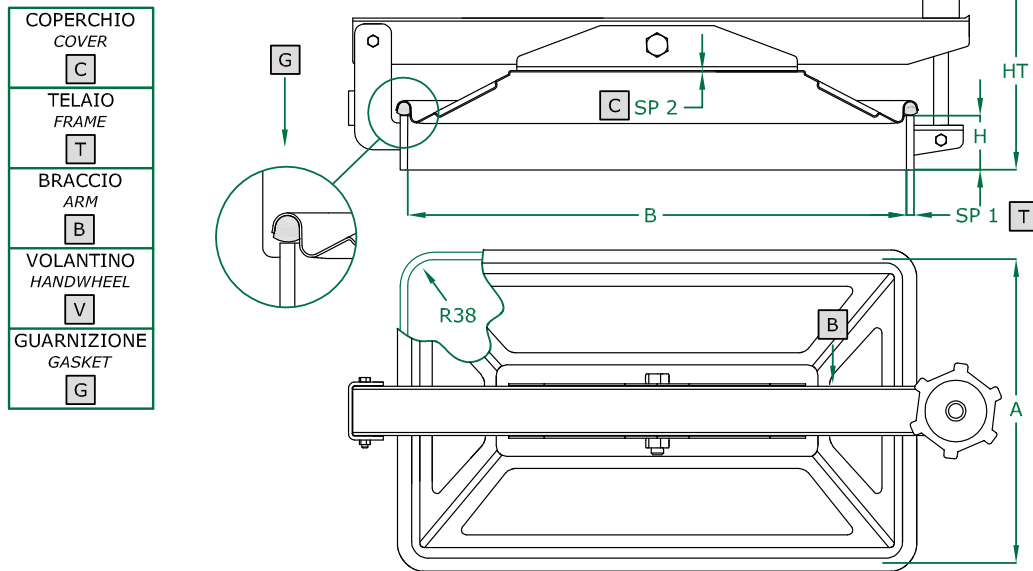



275 x 405 mm
Rev 1



	STANDARD		OPTIONAL			
H X SP1	50 X 6		100 X 6			
TELAIO	SAT		MPL			
GUARNIZIONE	PARA	EPDM	NEOPRENE	NBR	SILICONE	VITON
VOLANTINO	125 001 V NYLON	125 021 V NYLON	125 022 CHROME P.	125 023 S. STEEL	125 024 ALUMINIUM	125 031 S. STEEL

ART	A	B	SP2	HT (standard)	BAR max: (standard)	COVER type:	GASKET code:	KG (standard)
384L	275	405	1,0	165	0,3	CN	120 617	7

PORTELLA CIRCOLARE apertura esterna

-  ROUND manwaydoor outwards opening
-  Porte RONDE avec ouverture à l'extérieur
-  Puerta CIRCULAR de apertura externa
-  RUNDE Türchen, Aussenöffnung
-  КРУГЛАЯ крышка с внешним открытием
-  外开圆形人孔门

790 SERIE

200 / 220 / 300 DN
Rev 0



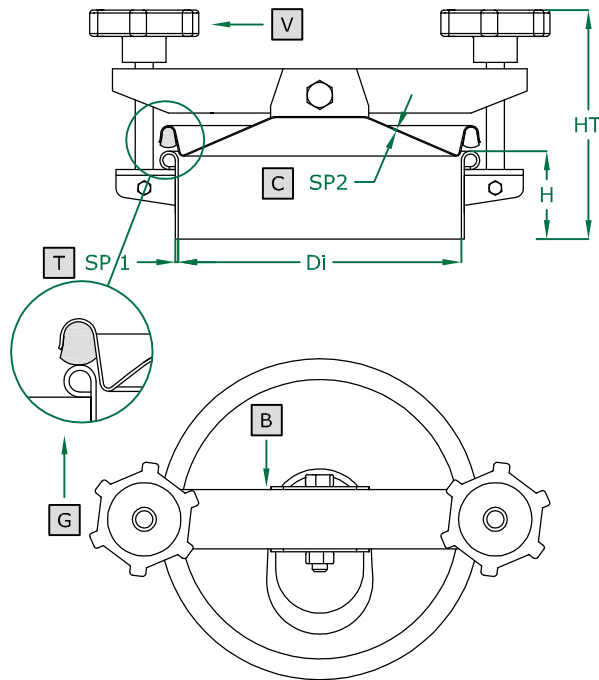



COPERCHIO COVER	C
TELAIO FRAME	T
BRACCIO ARM	B
VOLANTINO HANDWHEEL	V
GUARNIZIONE GASKET	G



	STANDARD		OPTIONAL			
H X SP1	60 X 2	100 X 2	...			
TELAIO	SAT	MPL	BA		FIO	
GUARNIZIONE	PARA	EPDM	NEOPRENE	NBR	SILICONE	VITON
VOLANTINO	125 001 V NYLON	125 021 V NYLON	125 022 CHROME P.	125 023 S. STEEL	125 024 ALUMINIUM	125 031 S.STEEL
FORO	NO	33	42	48	...	

ART	DN	Di	SP2	HT (standard)	BAR max: (standard)	COVER type:	GASKET code:	KG (standard)
790	200	195	1,0	145	0,5	CL	120 619	2,5
791	220	220	1,5	150	0,5	CA	120 802	5,0
792	300	295	1,0	165	0,3	CL	120 610	9,0

PORTELLA CIRCOLARE apertura esterna

-  ROUND manwaydoor outwards opening
-  Porte RONDE avec ouverture à l'extérieur
-  Puerta CIRCULAR de apertura externa
-  RUNDE Türchen, Aussenöffnung
-  КРУГЛАЯ крышка с внешним открытием
-  外开圆形人孔门

800 ART
300 DN
Rev 0



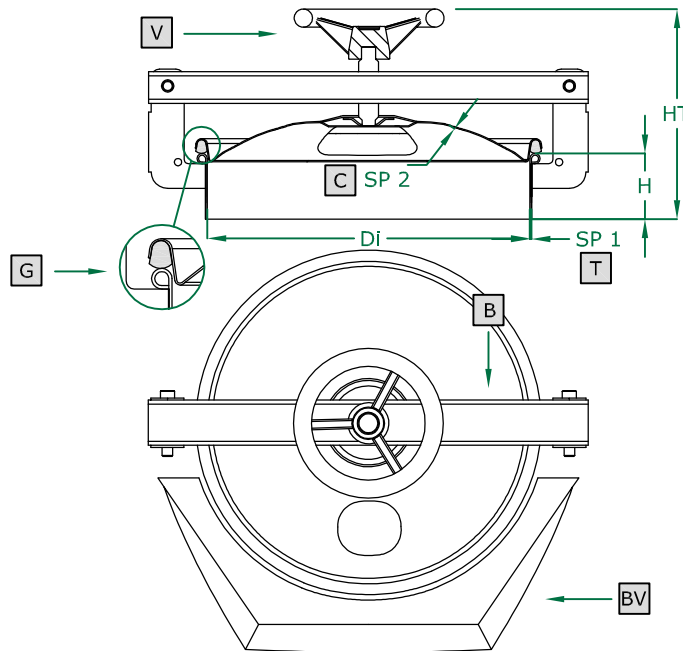



COPERCHIO COVER	C
TELAIO FRAME	T
BRACCIO ARM	B
VOLANTINO HANDWHEEL	V
GUARNIZIONE GASKET	G
BAVERINO DRIP	BV



	STANDARD	OPTIONAL			
H X SP1	60 X 2	100 X 2	60 x 8	100 x 8	
TELAIO	SAT	MPL	BA	FIO	
GUARNIZIONE	PARA	EPDM	NEOPRENE	NBR	SILICONE VITON
VOLANTINO	125 010 V NYLON		125 040 S. STEEL		
FORO	NO	33	42	48	...
BAVERINO	NO		DN 300		

ART	DN	Di	SP2	HT (standard)	BAR max: (standard)	COVER type:	GASKET code:	KG (standard)
800	300	295	1,0	175	0,5	CL	120 610	5,0

PORTELLA CIRCOLARE apertura esterna

-  ROUND manwaydoor outwards opening
-  Porte RONDE avec ouverture à l'extérieur
-  Puerta CIRCULAR de apertura externa
-  RUNDE Türchen, Aussenöffnung
-  КРУГЛАЯ крышка с внешним открытием
-  外开圆形人孔门

800 SERIE

380 / 400 / 420 DN
Rev 0



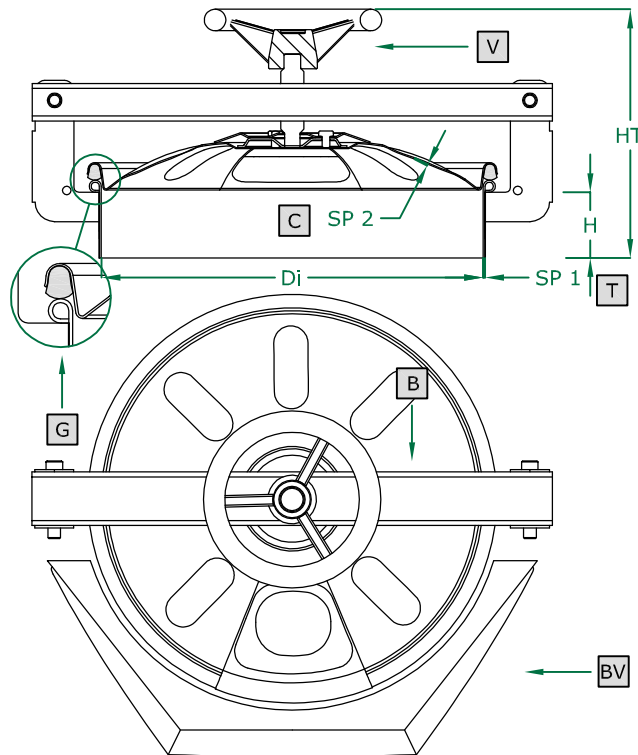



COPERCHIO COVER	C
TELAIO FRAME	T
BRACCIO ARM	B
VOLANTINO HANDWHEEL	V
GUARNIZIONE GASKET	G
BAVERINO DRIP	BV



	STANDARD	OPTIONAL			
H X SP1	60 X 2	100 X 2	60 X 8	100 X 8	...
TELAIO	SAT	MPL		BA	FIO
GUARNIZIONE	PARA	EPDM	NEOPRENE	NBR	SILICONE VITON
VOLANTINO	125 012 V NYLON			125 042 S. STEEL	
FORO	NO	33	42	48	...
BAVERINO	NO	DN 380		DN 400	DN 420

ART	DN	Di	SP2	HT (standard)	BAR max: (standard)	COVER type:	GASKET code:	KG (standard)	DRIP (baverino)
801	380	375	1,2	230	0,7	CN	120 611	7,6	103 016
802	400	395	1,5	235	0,7	CN	120 617	8,0	103 017
803	420	415	1,5	245	0,7	CN	120 612	8,2	103 018

PORTELLA CIRCOLARE apertura esterna

-  ROUND manwaydoor outwards opening
-  Porte RONDE avec ouverture à l'extérieur
-  Puerta CIRCULAR de apertura externa
-  RUNDE Türchen, Aussenöffnung
-  КРУГЛАЯ крышка с внешним открытием
-  外开圆形人孔门

800R SERIE

380 / 400 / 420 DN
Rev 0



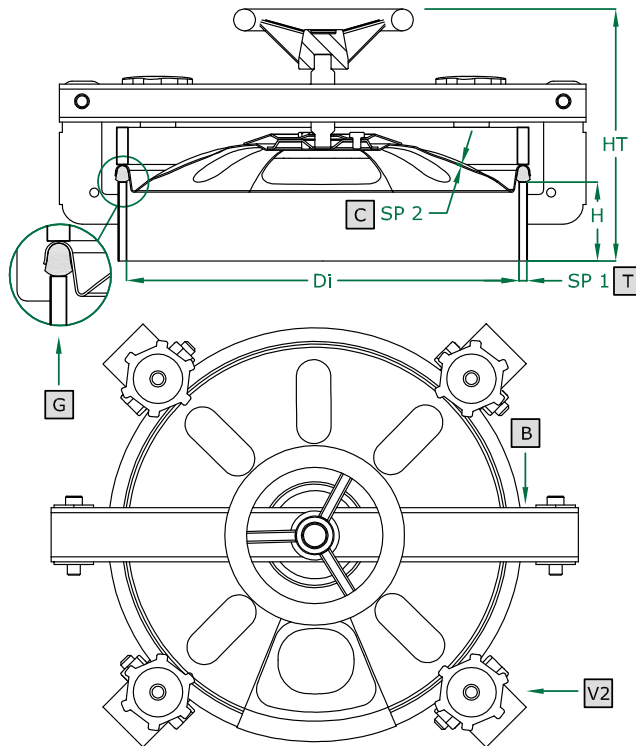



COPERCHIO COVER	C
TELAIO FRAME	T
BRACCIO ARM	B
VOLANTINO HANDWHEEL	V1
VOLANTINO HANDWHEEL	V2
GUARNIZIONE GASKET	G



	STANDARD	OPTIONAL				
H X SP1	60 X 8	100 X 8	RAGGIATURA			...
TELAIO	SAT	MPL				
GUARNIZIONE	PARA	EPDM	NEOPRENE	NBR	SILICONE	VITON
VOLANTINO	125 012 V NYLON			125 042 S. STEEL		
FORO	NO	33	42	48	...	

ART	DN	Di	SP2	HT (standard)	BAR max: (standard)	COVER type:	GASKET code:	KG (standard)
801R	380	375	1,2	230	2,0	CN	120 611	13,6
802R	400	395	1,5	235	2,0	CN	120 617	14,3
803R	420	415	1,5	245	2,0	CN	120 612	15,0

CHIUSINO CIRCOLARE

-  ROUND manhole cover
-  Trappe RONDE
-  Tapa CIRCULAR
-  RUNDE Klapptür
-  КРУГЛАЯ крышка люка
-  圆形人孔盖

520 SERIE

200/300/380/400/420/500/600 DN

Rev 0



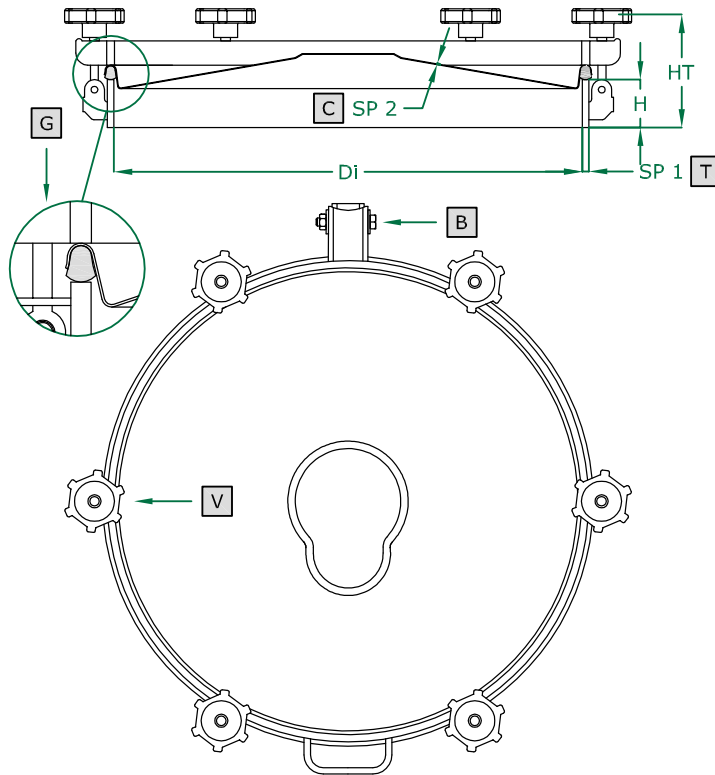



COPERCHIO COVER	C
TELAIO FRAME	T
BRACCIO ARM	B
VOLANTINO HANDWHEEL	V
GUARNIZIONE GASKET	G



	STANDARD		OPTIONAL			
H X SP1	60 X 8		100 X 8			
TELAIO	SAT		MPL			
GUARNIZIONE	PARA	EPDM	NEOPRENE	NBR	SILICONE	VITON
VOLANTINO	125 001 V NYLON	125 021 V NYLON	125 022 CHROME P.	125 023 S. STEEL	125 024 ALUMINUM	125 031 S.STEEL
FORO	NO	33	42	48	50	...
VALVOLA	NO		VAI ALLA PAG. Z5 / GO TO PAGE Z5			

ART	DN	Di	SP2	V (nr)	HT (standard)	BAR max: (standard)	COVER type:	GASKET code:	KG (standard)
519	200	195	1,0	4	125	3,0/-0,5	CL	120 619	7
520	300	295	1,0	4	125	3,0/-0,5	CL	120 610	9
521	380	375	1,0	4	125	2,0/-0,6	CN	120 611	10,5
522	400	395	1,2	6	125	2,0/-0,6	CN	120 617	11,8
523	420	415	1,2	6	125	2,0/-0,6	CN	120 612	13
524	500	500	1,2	6	125	1,3/-0,5	CL	120 616	14,5
525	600	600	1,5	6	125	1,0/-0,5	CL	120 607	18,5

CHIUSINO CIRCOLARE

-  ROUND manhole cover
-  Trappe RONDE
-  Tapa CIRCULAR
-  RUNDE Klapptür
-  КРУГЛАЯ крышка люка
-  圆形人孔盖

540 SERIE

200/300/380/400/420/500/600 DN

Rev 0

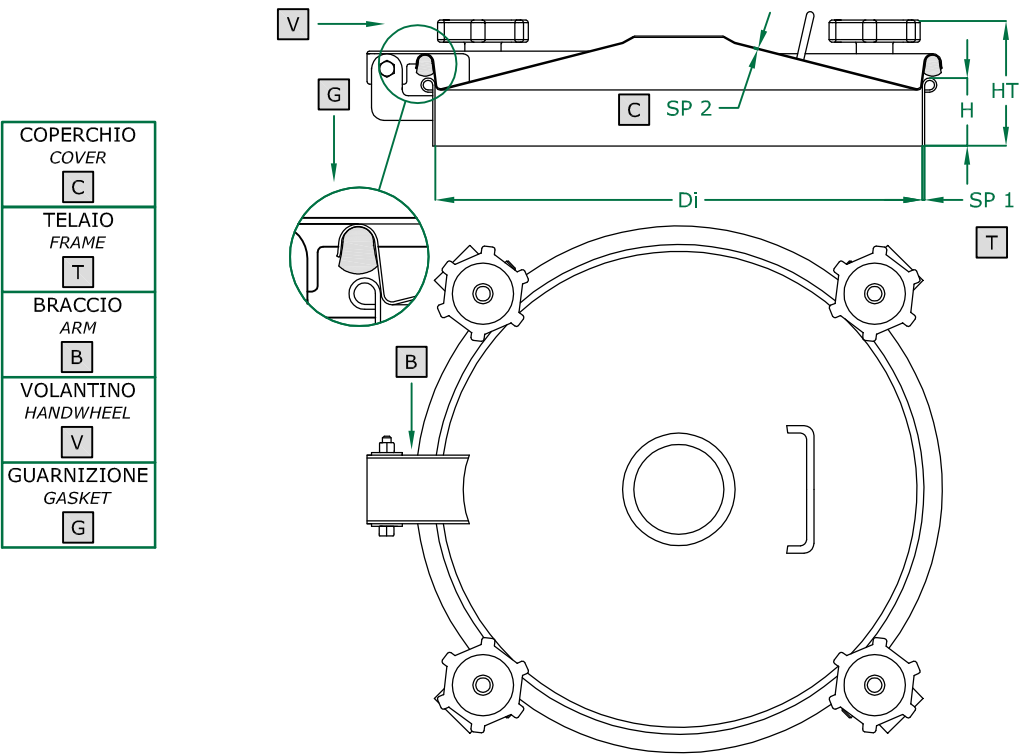







	STANDARD		OPTIONAL			
H X SP1	60 X 2	100 X 2	150 X 2	200 X 2	250 X 2	...
TELAIO	SAT	MPL		BA		FIO
GUARNIZIONE	PARA	EPDM	NEOPRENE	NBR	SILICONE	VITON
VOLANTINO	125 001 V NYLON	125 021 V NYLON	125 022 CHROME P.	125 023 S. STEEL	125 024 ALUMINIUM	125 031 S. STEEL
FORO	NO	33	42	48	50	...
VALVOLA	NO	VAI ALLA PAG. Z5 / GO TO PAGE Z5				

ART	DN	Di	SP2	V (nr)	HT (standard)	BAR max: (standard)	COVER type:	GASKET code:	KG (standard)
539	200	195	1,0	4	120	0,2	CL	120 619	3
540	300	295	1,0	4	120	0,2	CL	120 610	4,3
541	380	375	1,0	4	120	0,2	CN	120 611	5,3
542	400	395	1,2	4	125	0,2	CL	120 617	5,5
543	420	415	1,2	4	125	0,2	CN	120 612	5,8
544	500	500	1,2	6	125	0,2	CL	120 616	7
545	600	600	1,5	6	130	0,2	CL	120 607	10,5

Le immagini, i dati, i pesi, le caratteristiche tecniche a catalogo non sono impegnative. Ci riserviamo di apportare le modifiche necessarie, senza alcun preavviso. - The images, data, weights and technical specifications are not binding. We reserve the right to make the necessary alterations without prior notice.

CHIUSINO CIRCOLARE con chiusura CLAMP

-  ROUND manhole cover with clamp closing
-  Trappe RONDE avec collier de fermeture
-  Tapa CIRCULAR con cierre tirante de abrazadera
-  RUNDE Klapptür mit Klemmringverschluß
-  КРУГЛАЯ крышка люка с закрытием на зажимах
-  圆形人孔盖

550 SERIE



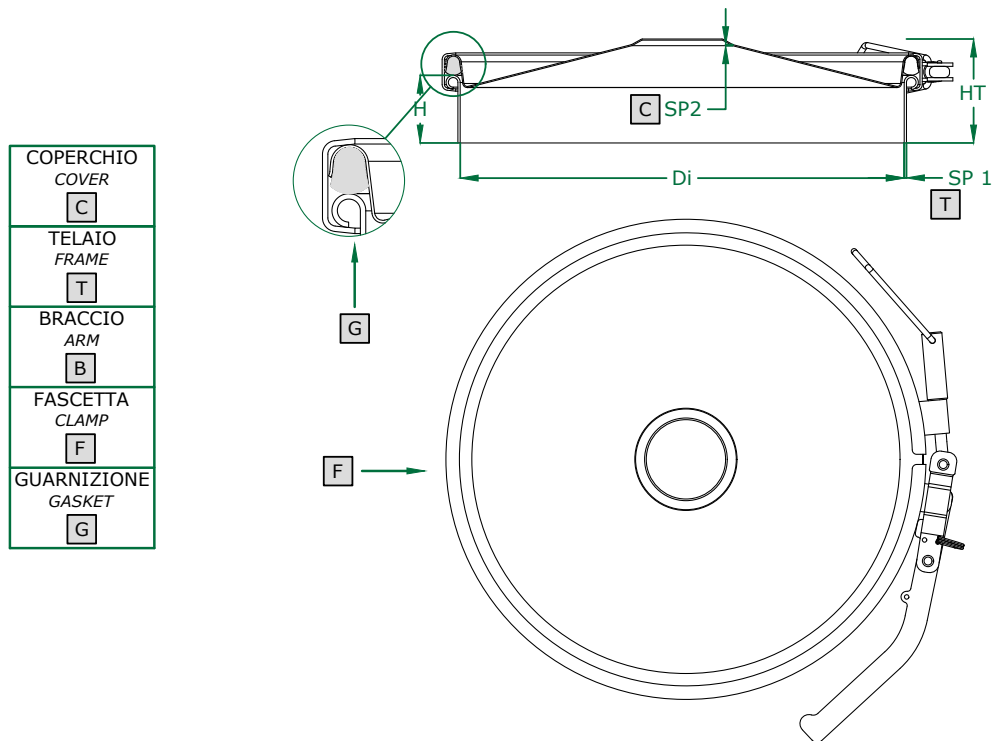



300/400/500/600 DN
Rev 1



	STANDARD	OPTIONAL				
H X SP1	60 X 2	100 X 2	150 X 2	200 X 2	250 X 2	...
TELAIO	SAT	MPL		BA		FIO
GUARNIZIONE	PARA	EPDM	NEOPRENE	NBR	SILICONE	VITON
FORO	NO	33	42	48	50	...
VALVOLA	NO	VAI ALLA PAG. Z5 / GO TO PAGE Z5				

ART	DN	Di	SP2	HT (standard)	BAR max: (standard)	COVER type:	GASKET code:	KG (standard)
550	300	295	1,0	80	1,8	CL	120 610	4
552	400	395	1,2	80	1,8	CL	120 617	5
554	500	500	1,2	85	1,3	CL	120 616	6,5
555	600	600	1,5	85	1,0	CL	120 607	8

CHIUSINO CIRCOLARE apertura a ribaltamento

-  ROUND manhole cover with back-side opening
-  Trappe RONDE avec ouverture par renversement
-  Tapa circular con apertura vertical
-  RUNDE Klapptür flapdoor
-  КРУГЛАЯ крышка люка с откидным открытием
-  圆形人孔盖

560 SERIE

200/300/380/400/420/500/600 DN

Rev 0



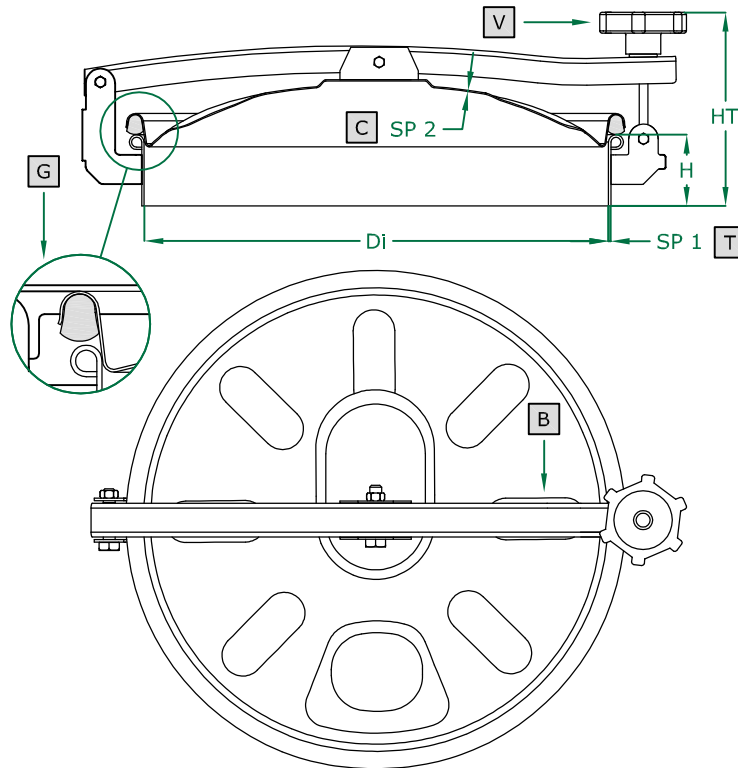



COPERCHIO COVER	C
TELAIO FRAME	T
BRACCIO ARM	B
VOLANTINO HANDWHEEL	V
GUARNIZIONE GASKET	G



	STANDARD		OPTIONAL			
H X SP1	60 X 2	100 X 2	150 X 2	200 X 2	250 X 2	...
TELAIO	SAT	MPL		BA		FIO
GUARNIZIONE	PARA	EPDM	NEOPRENE	NBR	SILICONE	VITON
VOLANTINO	125 001 V NYLON	125 021 V NYLON	125 022 CHROME P.	125 023 S. STEEL	125 024 ALUMINIUM	125 031 S. STEEL
FORO	NO	33	42	48	50	...
VALVOLA	NO	VAI ALLA PAG. Z5 / GO TO PAGE Z5				

ART	DN	Di	SP2	HT (standard)	BAR max: (standard)	COVER type:	GASKET code:	KG (standard)
559	200	195	1,0	120	0,04	CL	120 619	2,3
560	300	295	1,0	140	0,03	CL	120 610	3,0
561	380	375	1,0	145	0,02	CN	120 611	4,0
562	400	395	1,2	150	0,02	CN	120 617	4,5
563	420	415	1,2	150	0,02	CN	120 612	5,0
564	500	500	1,2	155	0,02	CL	120 616	6,0
565	600	600	1,5	160	0,01	CL	120 607	9,0

CHIUSINO CIRCOLARE apertura a ribaltamento

-  ROUND manhole cover with back-side opening
-  Trappe RONDE avec ouverture par renversement
-  Tapa circular con apertura vertical
-  RUNDE Klapptür flapdoor
-  КРУГЛАЯ крышка люка с откидным открытием
-  圆形人孔盖

560R SERIE

300/380/400/420/500/600 DN

Rev 0



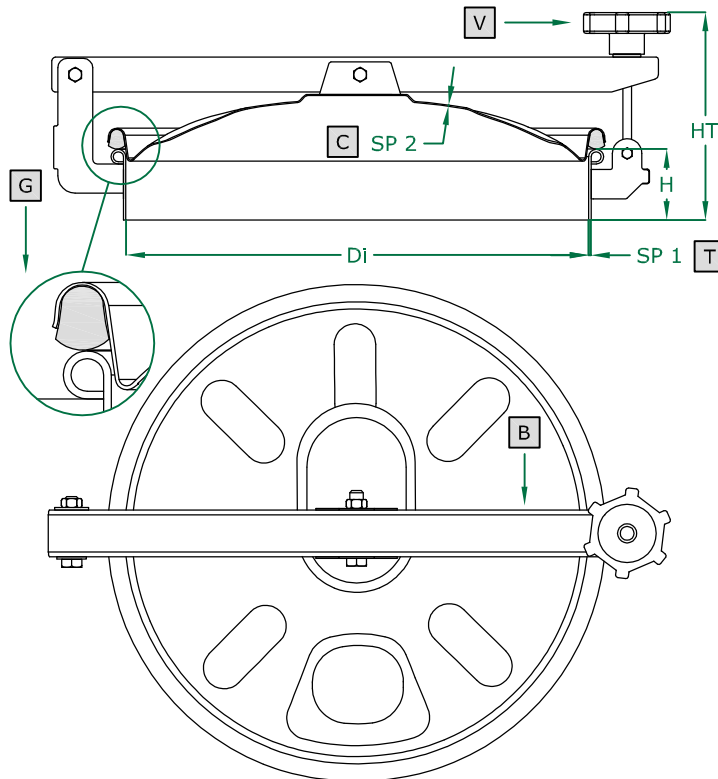



COPERCHIO COVER	C
TELAIO FRAME	T
BRACCIO ARM	B
VOLANTINO HANDWHEEL	V
GUARNIZIONE GASKET	G



	STANDARD		OPTIONAL			
H X SP1	60 X 2	100 X 2	150 X 2	200 X 2	250 X 2	...
TELAIO	SAT	MPL		BA		FIO
GUARNIZIONE	PARA	EPDM	NEOPRENE	NBR	SILICONE	VITON
VOLANTINO	125 001 V NYLON	125 021 V NYLON	125 022 CHROME P.	125 023 S. STEEL	125 024 ALUMINIUM	125 031 S. STEEL
FORO	NO	33	42	48	50	...
VALVOLA	NO	VAI ALLA PAG. Z5 / GO TO PAGE Z5				

ART	DN	Di	SP2	HT (standard)	BAR max: (standard)	COVER type:	GASKET code:	KG (standard)
560R	300	295	1,0	140	0,06	CL	120 610	3,5
561R	380	375	1,0	145	0,05	CN	120 611	4,6
562R	400	395	1,2	150	0,05	CN	120 617	5,5
563R	420	415	1,2	150	0,05	CN	120 612	6,0
564R	500	500	1,2	155	0,05	CL	120 616	7,0
565R	600	600	1,5	160	0,04	CL	120 607	9,5

CHIUSINO CIRCOLARE apertura a ribaltamento e bandiera

-  ROUND manhole cover with back-side and side-swing opening
-  Trappe RONDE avec ouverture par renversement et par glissement latéral
-  Tapa CIRCULAR con apertura tanto vertical como lateral
-  RUNDE Klapptür mit seitlich drehbare Öffnungs- und Kippöffnungssysteme
-  КРУГЛАЯ крышка люка с откидным и боковым шарнирным открытием
-  圆形人孔盖

570 SERIE

200/300/380/400/420/500/600 DN

Rev 0

COPERCHIO COVER	C
TELAIO FRAME	T
BRACCIO ARM	B
VOLANTINO HANDWHEEL	V
GUARNIZIONE GASKET	G

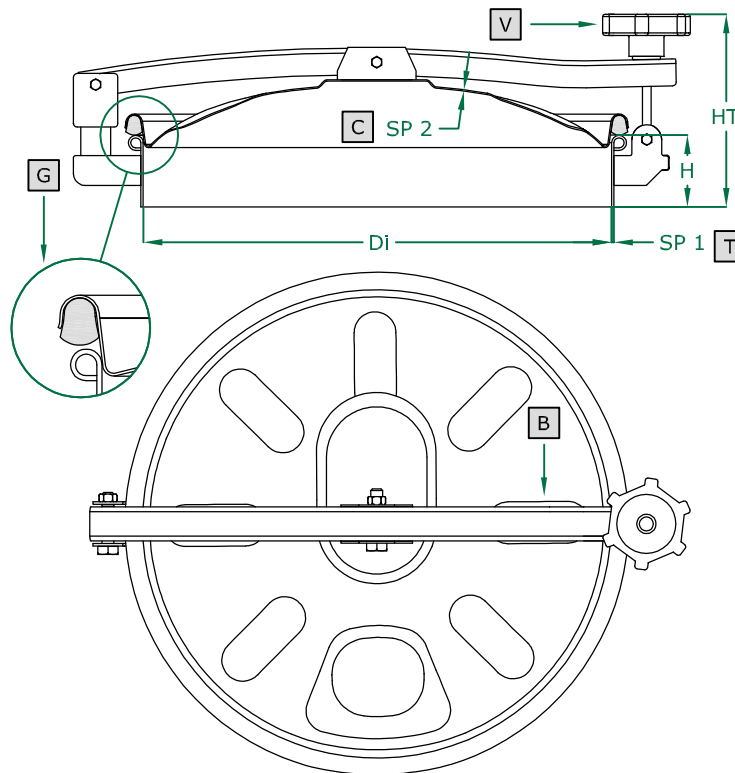







	STANDARD		OPTIONAL			
H X SP1	60 X 2	100 X 2	150 X 2	200 X 2	250 X 2	...
TELAIO	SAT	MPL	BA		FIO	
GUARNIZIONE	PARA	EPDM	NEOPRENE	NBR	SILICONE	VITON
VOLANTINO	125 001 V	125 021	125 022	125 023	125 024	125 031
FORO	NO	33	42	48	50	...
VALVOLA	NO					

VAI ALLA PAG. Z5 / GO TO PAGE Z5

ART	DN	Di	SP2	HT (standard)	BAR max: (standard)	COVER type:	GASKET code:	KG (standard)
569	200	195	1,0	120	0,04	CL	120 619	2,5
570	300	295	1,0	140	0,03	CL	120 610	3,5
571	380	375	1,0	145	0,02	CN	120 611	4,5
572	400	395	1,2	150	0,02	CN	120 617	5,5
573	420	415	1,2	150	0,02	CN	120 612	6,0
574	500	500	1,2	155	0,02	CL	120 616	7,0
575	600	600	1,5	160	0,01	CL	120 607	9,0

CHIUSINO CIRCOLARE apertura a ribaltamento e bandiera

-  ROUND manhole cover with back-side and side-swing opening
-  Trappe RONDE avec ouverture par renversement et par glissement latéral
-  Tapa CIRCULAR con apertura tanto vertical como lateral
-  RUNDE Klapptür mit seitlich drehbare Öffnungs- und Kippöffnungssysteme
-  КРУГЛАЯ крышка люка с откидным и боковым шарнирным открытием
-  圆形人孔盖

570R SERIE

300/380/400/420/500/600 DN

Rev 0

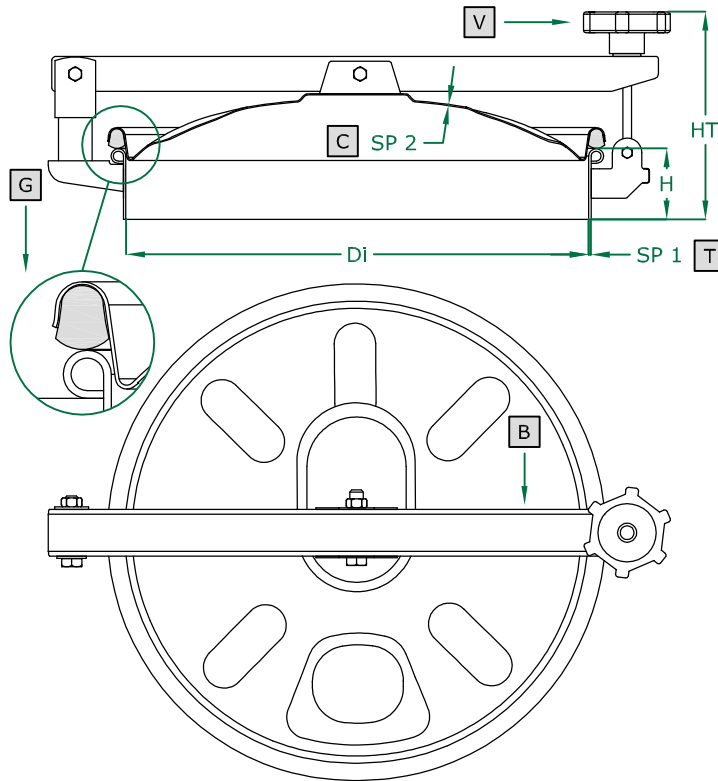

COPERCHIO COVER	C
TELAIO FRAME	T
BRACCIO ARM	B
VOLANTINO HANDWHEEL	V
GUARNIZIONE GASKET	G



	STANDARD		OPTIONAL			
H X SP1	60 X 2	100 X 2	150 X 2	200 X 2	250 X 2	...
TELAIO	SAT	MPL	BA		FIO	
GUARNIZIONE	PARA	EPDM	NEOPRENE	NBR	SILICONE	VITON
VOLANTINO	125 001 V	125 021	125 022	125 023	125 024	125 031
FORO	NO	33	42	48	50	...
VALVOLA	NO	VAI ALLA PAG. Z5 / GO TO PAGE Z5				

ART	DN	Di	SP2	HT (standard)	BAR max: (standard)	COVER type:	GASKET code:	KG (standard)
570R	300	295	1,0	140	0,06	CL	120 610	3,7
571R	380	375	1,0	145	0,05	CN	120 611	4,8
572R	400	395	1,2	150	0,05	CN	120 617	5,7
573R	420	415	1,2	150	0,05	CN	120 612	6,2
574R	500	500	1,2	155	0,05	CL	120 616	7,2
575R	600	600	1,5	160	0,04	CL	120 607	9,7

CHIUSINO CIRCOLARE

-  ROUND manhole cover
-  Trappe RONDE
-  Tapa CIRCULAR
-  RUNDE Klapptür
-  КРУГЛАЯ крышка люка
-  圆形人孔盖

580 SERIE
200/300/380/400/420/500/600 DN
Rev 01



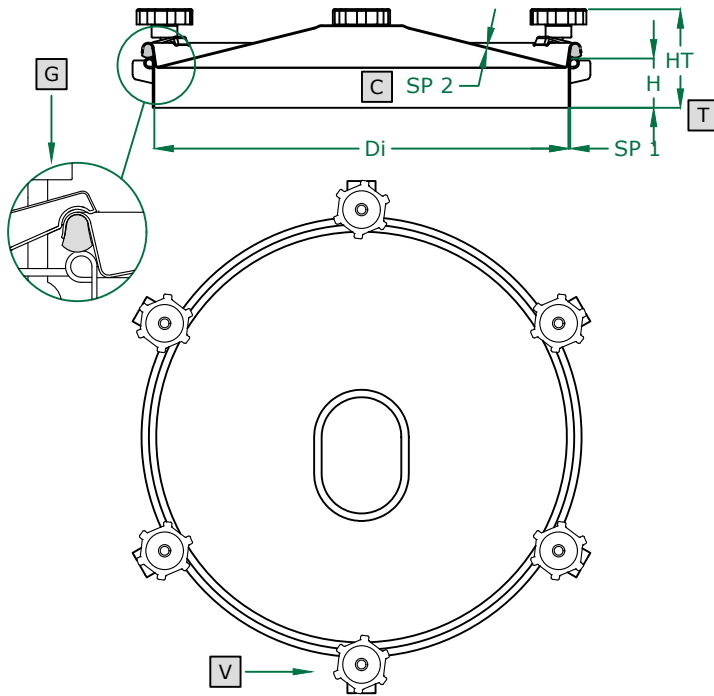

COPERCHIO COVER	C
TELAIO FRAME	T
BRACCIO ARM	B
VOLANTINO HANDWHEEL	V
GUARNIZIONE GASKET	G



	STANDARD		OPTIONAL			
H X SP1	60 X 2	100 X 2	150 X 2	200 X 2	250 X 2	...
TELAIO	SAT	MPL		BA		FIO
GUARNIZIONE	PARA	EPDM	NEOPRENE	NBR	SILICONE	VITON
VOLANTINO	125 001 V NYLON	125 021 V NYLON	125 022 CHROME P.	125 023 S. STEEL	125 024 ALUMINIUM	125 031 S. STEEL
FORO	NO	33	42	48	50	...
VALVOLA	NO	VAI ALLA PAG. Z5 / GO TO PAGE Z5				

ART	DN	Di	SP2	V (nr)	HT (standard)	BAR max: (standard)	COVER type:	GASKET code:	KG (standard)
579	200	195	1,0	3	105	0,2	CL	120 619	2,0
580	300	295	1,0	3	110	0,2	CL	120 610	3,0
581	380	375	1,0	4	111	0,2	CN	120 611	4,3
582	400	395	1,2	4	112	0,2	CL	120 617	4,5
583	420	415	1,2	4	113	0,2	CN	120 612	4,8
584	500	500	1,2	6	115	0,2	CL	120 616	6,0
585	600	600	1,5	6	115	0,2	CL	120 607	9,5

CHIUSINO CIRCOLARE

-  ROUND manhole cover
-  Trappe RONDE
-  Tapa CIRCULAR
-  RUNDE Klapptür
-  КРУГЛАЯ крышка люка
-  圆形人孔盖

590 SERIE

300/380/400/420/500/600 DN

Rev 0



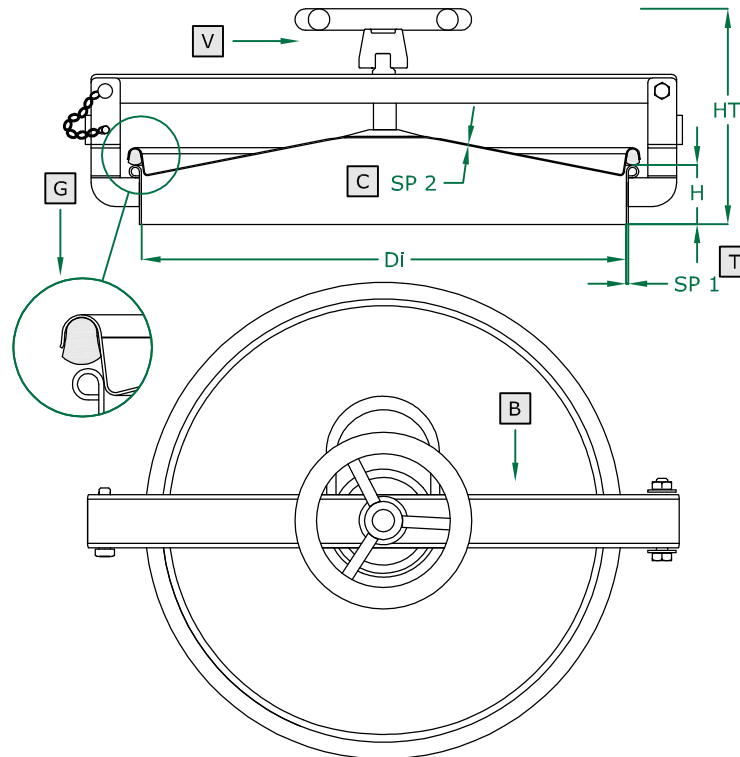



COPERCHIO COVER	C
TELAIO FRAME	T
BRACCIO ARM	B
VOLANTINO HANDWHEEL	V
GUARNIZIONE GASKET	G



	STANDARD	OPTIONAL				
H X SP 1	60 X 2	100 X 2	150 X 2	200 X 2	250 X 2	...
TELAIO	SAT	MPL		BA		FIO
GUARNIZIONE	PARA	EPDM	NEOPRENE	NBR	SILICONE	VITON
VOLANTINO	125 010 V NYLON			125 040 S. STEEL		
FORO	NO	33	42	48	50	...
VALVOLA	NO	VAI ALLA PAG. Z5 / GO TO PAGE Z5				

ART	DN	Di	SP2	HT (standard)	BAR max: (standard)	COVER type:	GASKET code:	KG (standard)
590	300	295	1,0	195	0,02	CL	120 610	4,2
591	380	375	1,0	200	0,02	CN	120 611	5,3
592	400	395	1,2	200	0,02	CN	120 617	5,6
593	420	415	1,2	200	0,02	CN	120 612	6,5
594	500	500	1,2	205	0,02	CL	120 616	7,0
595	600	600	1,5	210	0,02	CL	120 607	9,0

CHIUSINO CIRCOLARE

-  ROUND manhole cover
-  Trappe RONDE
-  Tapa CIRCULAR
-  RUNDE Klapptür
-  КРУГЛАЯ крышка люка
-  圆形人孔盖

930 SERIE

150/220/300/400/500/600 DN

Rev 0

COPERCHIO COVER	C
TELAIO FRAME	T
BRACCIO ARM	B
VOLANTINO HANDWHEEL	V
G. COPERCHIO G. COVER	GC
G. TELAIO G. FRAME	GT

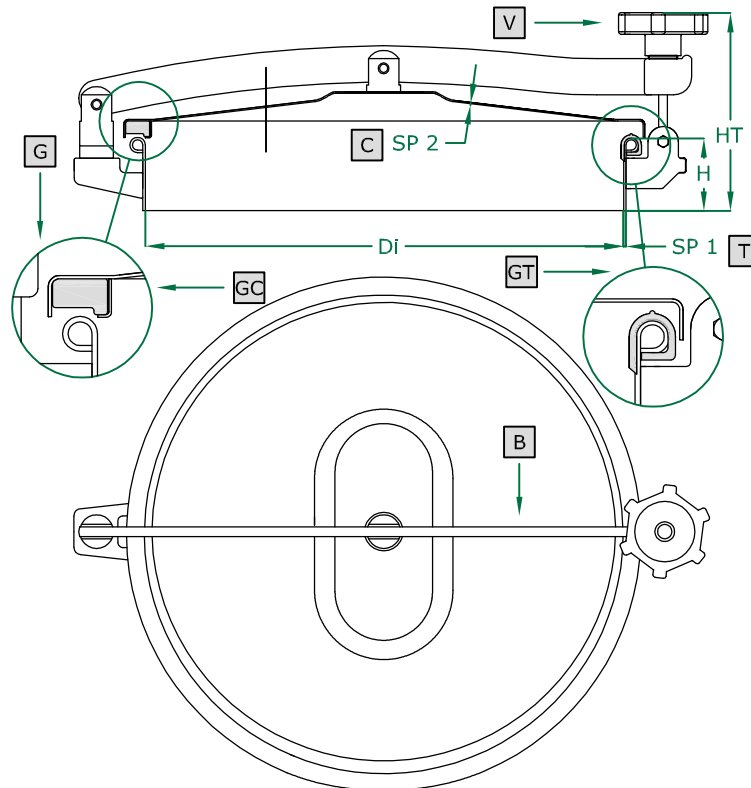

GUARNIZIONE TELAIO / GASKET ON FRAME







ART	DN	Di	SP2	HT (standard)	BAR max: (standard)	COVER type:	GASKET code:	KG (standard)
929	220	220	1,5	150	0,04	CA	120 702	3,0
930	300	295	1,5	155	0,03	CA	120 703	4,0
932	400	395	1,5	160	0,02	CA	120 704	5,2
934	500	500	1,5	165	0,02	CA	120 705	7,0
935	600	600	1,5	170	0,01	CA	120 706	9,5

GUARNIZIONE COPERCHIO / GASKET ON COVER

ART	DN	Di	SP2	HT (standard)	BAR max: (standard)	COVER type:	GASKET code:	KG (standard)
928B	150	150	1,5	140	0,04	CA	120 801	2,3
929B	220	220	1,5	145	0,04	CA	120 802	3,5
930B	300	295	1,5	150	0,03	CA	120 803	4,3
932B	400	395	1,5	155	0,02	CA	120 804	6,0
934B	500	500	1,5	160	0,02	CA	120 805	7,7
935B	600	600	1,5	165	0,01	CA	120 806	10,3

	STANDARD	OPTIONAL				
H X SP1	60 X 2	100 X 2	150 X 2	200 X 2	250 X 2	...
TELAIO	SAT	MPL		BA		FIO
GUARNIZIONE	PARA	EPDM	NEOPRENE	NBR	SILICONE	VITON
VOLANTINO	125 001 V NYLON	125 021 V NYLON	125 022 CHROME P.	125 023 S. STEEL	125 024 ALUMINIUM	125 031 S. STEEL
FORO	NO	33	42	48	50	...
VALVOLA	NO	VAI ALLA PAG. Z5 / GO TO PAGE Z5				

CHIUSINO CIRCOLARE

-  ROUND manhole cover
-  Trappe RONDE
-  Tapa CIRCULAR
-  RUNDE Klapptür
-  КРУГЛАЯ крышка люка
-  圆形人孔盖

940 SERIE
220/300/400/500/600 DN
Rev 02

COPERCHIO COVER	C
TELAIO FRAME	T
BRACCIO ARM	B
VOLANTINO HANDWHEEL	V
G. COPERCHIO G. COVER	GC
G. TELAIO G. FRAME	GT

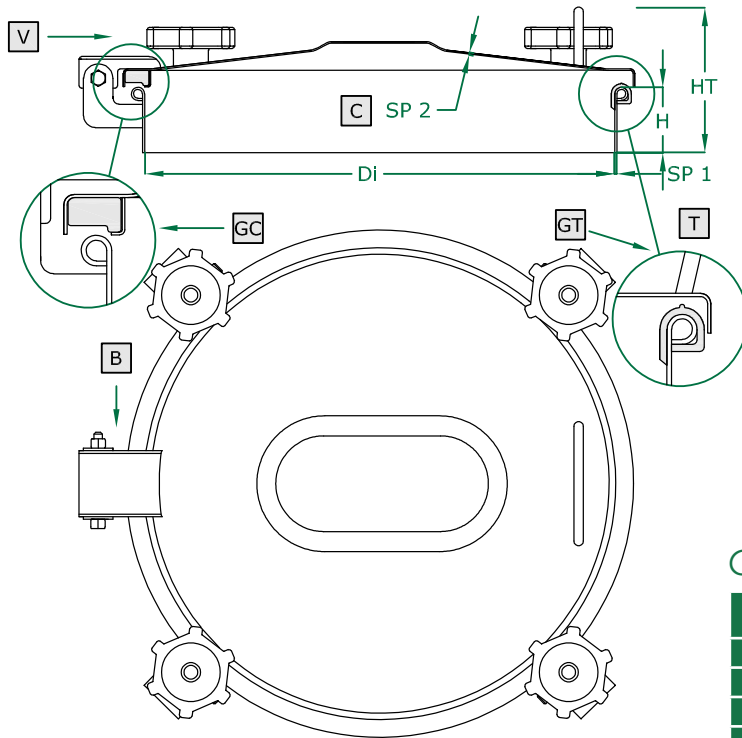

GUARNIZIONE TELAIO / GASKET ON FRAME







ART	DN	Di	SP2	V (nr)	HT (standard)	BAR max: (standard)	COVER type:	GASKET code:	KG (standard)
939	220	220	1,5	4	110	0,2	CA	120 702	3,8
940	300	295	1,5	4	120	0,2	CA	120 703	5,0
942	400	395	1,5	4	120	0,2	CA	120 704	5,5
944	500	500	1,5	6	125	0,2	CA	120 705	7,5
945	600	600	1,5	6	130	0,2	CA	120 706	8,5

GUARNIZIONE COPERCHIO / GASKET ON COVER

ART	DN	Di	SP2	V (nr)	HT (standard)	BAR max: (standard)	COVER type:	GASKET code:	KG (standard)
939B	220	220	1,5	4	110	0,2	CA	120 802	4,0
940B	300	295	1,5	4	120	0,2	CA	120 803	6,0
942B	400	395	1,5	4	120	0,2	CA	120 804	6,5
944B	500	500	1,5	6	125	0,2	CA	120 805	8,0
945B	600	600	1,5	6	130	0,2	CA	120 806	9,0

	STANDARD		OPTIONAL			
H X SP1	60 X 2	100 X 2	150 X 2	200 X 2	250 X 2	...
TELAIO	SAT	MPL		BA		FIO
GUARNIZIONE	PARA	EPDM	NEOPRENE	NBR	SILICONE	VITON
VOLANTINO	125 001 V NYLON	125 021 V NYLON	125 022 CHROME P.	125 023 S. STEEL	125 024 ALUMINIUM	125 031 S. STEEL
FORO	NO	33	42	48	50	...
VALVOLA	NO	VAI ALLA PAG. Z5 / GO TO PAGE Z5				

CHIUSINO CIRCOLARE apertura a ribaltamento

-  ROUND manhole cover with back-side opening
-  Trappe RONDE avec ouverture par renversement
-  Tapa circular con apertura vertical
-  RUNDE Klapptür flapdoor
-  КРУГЛАЯ крышка люка с откидным открытием
-  圆形人孔盖

960 SERIE

150/220/300/400/500/600 DN

Rev 0

COPERCHIO COVER	C
TELAIO FRAME	T
BRACCIO ARM	B
VOLANTINO HANDWHEEL	V
G. COPERCHIO G. COVER	GC
G. TELAIIO G. FRAME	GT

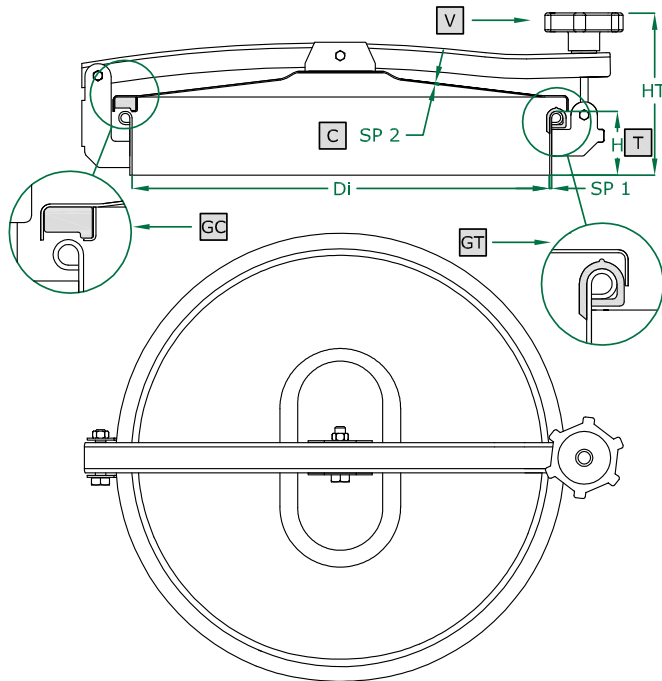

GUARNIZIONE TELAIIO / GASKET ON FRAME







ART	DN	Di	SP2	HT (standard)	BAR max: (standard)	COVER type:	GASKET code:	KG (standard)
959	220	220	1,5	125	0,02	CA	120 702	3,0
960	300	295	1,5	140	0,02	CA	120 703	4,0
962	400	395	1,5	150	0,02	CA	120 704	5,0
964	500	500	1,5	155	0,02	CA	120 705	6,0
965	600	600	1,5	160	0,02	CA	120 706	8,9

GUARNIZIONE COPERCHIO / GASKET ON COVER

ART	DN	Di	SP2	HT (standard)	BAR max: (standard)	COVER type:	GASKET code:	KG (standard)
958B	150	150	1,5	120	0,02	CA	120 801	1,8
959B	220	220	1,5	125	0,02	CA	120 802	2,7
960B	300	295	1,5	140	0,02	CA	120 803	3,7
962B	400	395	1,5	150	0,02	CA	120 804	6,0
964B	500	500	1,5	155	0,02	CA	120 805	7,0
965B	600	600	1,5	160	0,02	CA	120 806	10,0

	STANDARD		OPTIONAL			
H X SP1	60 X 2	100 X 2	150 X 2	200 X 2	250 X 2	...
TELAIO	SAT	MPL		BA		FIO
GUARNIZIONE	PARA	EPDM	NEOPRENE	NBR	SILICONE	VITON
VOLANTINO	125 001 V NYLON	125 021 V NYLON	125 022 CHROME P.	125 023 S. STEEL	125 024 ALUMINIUM	125 031 S. STEEL
FORO	NO	33	42	48	50	...
VALVOLA	NO	VAI ALLA PAG. Z5 / GO TO PAGE Z5				

CHIUSINO CIRCOLARE apertura a ribaltamento

-  ROUND manhole cover with back-side opening
-  Trappe RONDE avec ouverture par renversement
-  Tapa circular con apertura vertical
-  RUNDE Klapptür flapdoor
-  КРУГЛАЯ крышка люка с откидным открытием
-  圆形人孔盖

COPERCHIO COVER	C
TELAIO FRAME	T
BRACCIO ARM	B
VOLANTINO HANDWHEEL	V
G. COPERCHIO G. COVER	GC
G. TELAIIO G. FRAME	GT

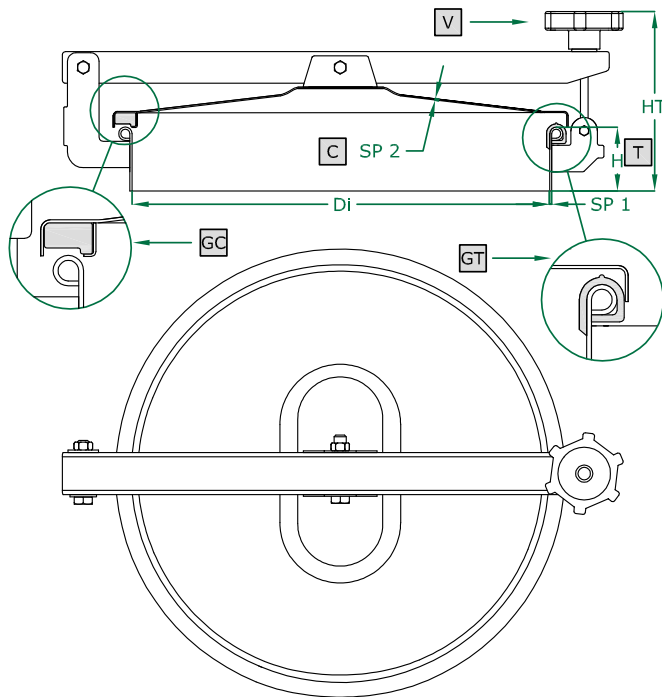

960R SERIE

220/300/400/500/600 DN

Rev 0



GUARNIZIONE TELAIIO / GASKET ON FRAME







ART	DN	Di	SP2	HT (standard)	BAR max: (standard)	COVER type:	GASKET code:	KG (standard)
959R	220	220	1,5	125	0,05	CA	120 702	4,0
960R	300	295	1,5	140	0,05	CA	120 703	5,0
962R	400	395	1,5	150	0,05	CA	120 704	6,0
964R	500	500	1,5	155	0,05	CA	120 705	7,0
965R	600	600	1,5	160	0,05	CA	120 706	9,9

GUARNIZIONE COPERCHIO / GASKET ON COVER

ART	DN	Di	SP2	HT (standard)	BAR max: (standard)	COVER type:	GASKET code:	KG (standard)
959RB	220	220	1,5	125	0,05	CA	120 802	3,7
960RB	300	295	1,5	140	0,05	CA	120 803	4,7
962RB	400	395	1,5	150	0,05	CA	120 804	7,0
964RB	500	500	1,5	155	0,05	CA	120 805	8,0
965RB	600	600	1,5	160	0,05	CA	120 806	11,0

	STANDARD		OPTIONAL			
H X SP1	60 X 2	100 X 2	150 X 2	200 X 2	250 X 2	...
TELAIO	SAT	MPL		BA		FIO
GUARNIZIONE	PARA	EPDM	NEOPRENE	NBR	SILICONE	VITON
VOLANTINO	125 001 V NYLON	125 021 V NYLON	125 022 CHROME P.	125 023 S. STEEL	125 024 ALUMINIUM	125 031 S. STEEL
FORO	NO	33	42	48	50	...
VALVOLA	NO	VAI ALLA PAG. Z5 / GO TO PAGE Z5				

CHIUSINO CIRCOLARE apertura a ribaltamento e bandiera

-  ROUND manhole cover with back-side and side-swing opening
-  Trappe RONDE avec ouverture par renversement et par glissement latéral
-  Tapa CIRCULAR con apertura tanto vertical como lateral
-  RUNDE Klapptür mit seitlich drehbare Öffnungs- und Kippöffnungssysteme
-  КРУГЛАЯ крышка люка с откидным и боковым шарнирным открытием
-  圆形人孔盖

970 SERIE

150/220/300/400/500/600 DN

Rev 0

COPERCHIO COVER	C
TELAIO FRAME	T
BRACCIO ARM	B
VOLANTINO HANDWHEEL	V
G. COPERCHIO G. COVER	GC
G. TELAIO G. FRAME	GT

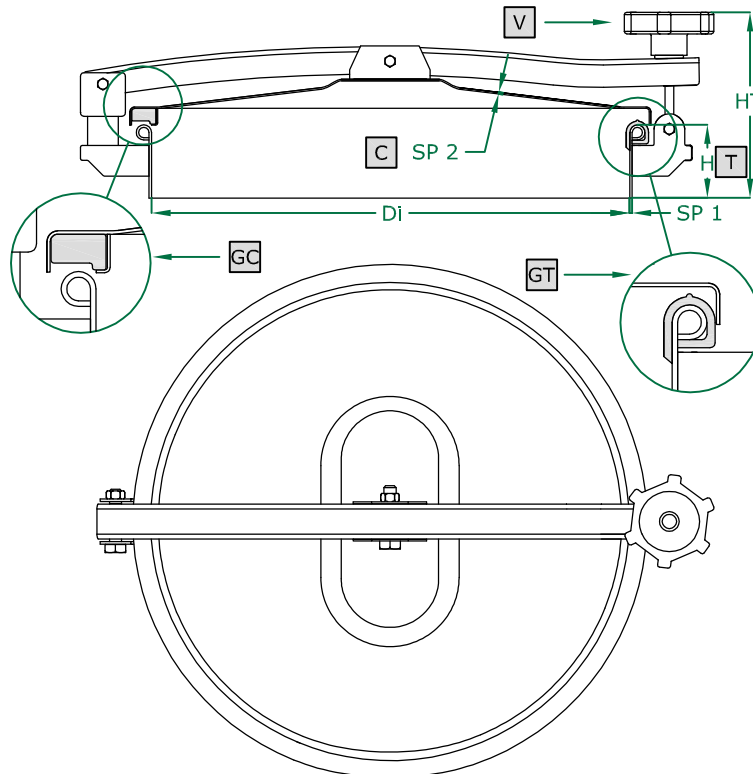

GUARNIZIONE TELAIO / GASKET ON FRAME







ART	DN	Di	SP2	HT (standard)	BAR max: (standard)	COVER type:	GASKET code:	KG (standard)
969	220	220	1,5	125	0,02	CA	120 702	3,0
970	300	295	1,5	140	0,02	CA	120 703	4,0
972	400	395	1,5	150	0,02	CA	120 704	5,0
974	500	500	1,5	155	0,02	CA	120 705	6,0
975	600	600	1,5	160	0,02	CA	120 706	9,0

GUARNIZIONE COPERCHIO / GASKET ON COVER

ART	DN	Di	SP2	HT (standard)	BAR max: (standard)	COVER type:	GASKET code:	KG (standard)
968B	150	150	1,5	120	0,02	CA	120 801	2,0
969B	220	220	1,5	125	0,02	CA	120 802	3,0
970B	300	295	1,5	140	0,02	CA	120 803	4,5
972B	400	395	1,5	150	0,02	CA	120 804	6,0
974B	500	500	1,5	155	0,02	CA	120 805	7,5
975B	600	600	1,5	160	0,02	CA	120 806	10,0

	STANDARD	OPTIONAL				
H X SP1	60 X 2	100 X 2	150 X 2	200 X 2	250 X 2	...
TELAIO	SAT	MPL		BA		FIO
GUARNIZIONE	PARA	EPDM	NEOPRENE	NBR	SILICONE	VITON
VOLANTINO	125 001 V NYLON	125 021 V NYLON	125 022 CHROME P.	125 023 S. STEEL	125 024 ALUMINIUM	125 031 S. STEEL
FORO	NO	33	42	48	50	...
VALVOLA	NO	VAI ALLA PAG. Z5 / GO TO PAGE Z5				

CHIUSINO CIRCOLARE apertura a ribaltamento e bandiera

-  ROUND manhole cover with back-side and side-swing opening
-  Trappe RONDE avec ouverture par renversement et par glissement latéral
-  Tapa CIRCULAR con apertura tanto vertical como lateral
-  RUNDE Klapptür mit seitlich drehbare Öffnungs- und Kippöffnungssysteme
-  КРУГЛАЯ крышка люка с откидным и боковым шарнирным открытием
-  圆形人孔盖

COPERCHIO COVER	C
TELAIO FRAME	T
BRACCIO ARM	B
VOLANTINO HANDWHEEL	V
G. COPERCHIO G. COVER	GC
G. TELAIO G. FRAME	GT

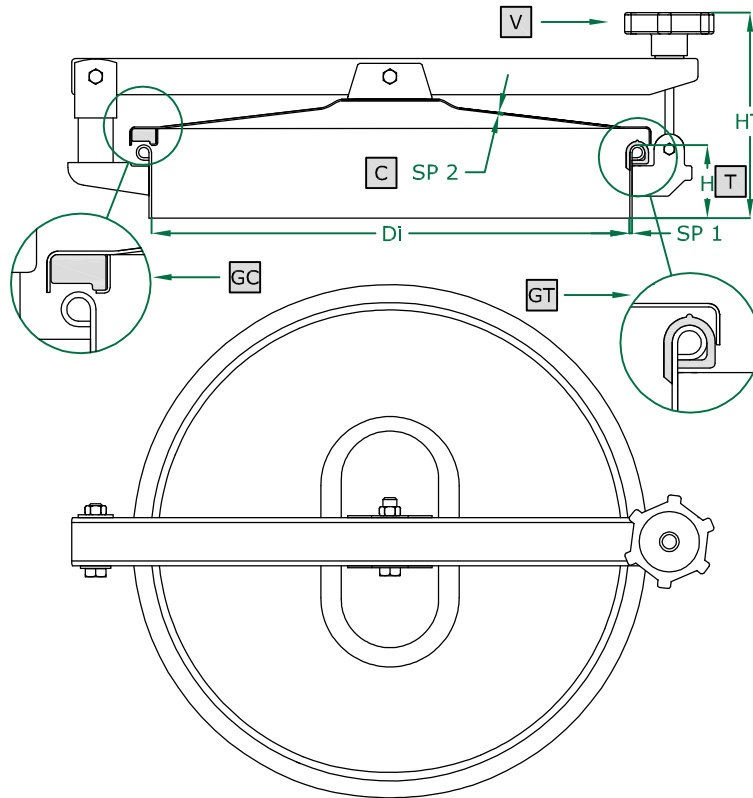

970R SERIE

220/300/400/500/600 DN

Rev 0

GUARNIZIONE TELAIO / GASKET ON FRAME







ART	DN	Di	SP2	HT (standard)	BAR max: (standard)	COVER type:	GASKET code:	KG (standard)
969R	220	220	1,5	125	0,05	CA	120 702	4,0
970R	300	295	1,5	140	0,05	CA	120 703	5,0
972R	400	395	1,5	150	0,05	CA	120 704	6,0
974R	500	500	1,5	155	0,05	CA	120 705	7,0
975R	600	600	1,5	160	0,05	CA	120 706	10,0

GUARNIZIONE COPERCHIO / GASKET ON COVER

ART	DN	Di	SP2	HT (standard)	BAR max: (standard)	COVER type:	GASKET code:	KG (standard)
969RB	220	220	1,5	125	0,05	CA	120 802	4,0
970RB	300	295	1,5	140	0,05	CA	120 803	5,5
972RB	400	395	1,5	150	0,05	CA	120 804	7,0
974RB	500	500	1,5	155	0,05	CA	120 805	8,5
975RB	600	600	1,5	160	0,05	CA	120 806	11,0

	STANDARD		OPTIONAL			
H X SP1	60 X 2	100 X 2	150 X 2	200 X 2	250 X 2	...
TELAIO	SAT	MPL		BA		FIO
GUARNIZIONE	PARA	EPDM	NEOPRENE	NBR	SILICONE	VITON
VOLANTINO	125 001 V NYLON	125 021 V NYLON	125 022 CHROME P.	125 023 S. STEEL	125 024 ALUMINIUM	125 031 S. STEEL
FORO	NO	33	42	48	50	...
VALVOLA	NO	VAI ALLA PAG. Z5 / GO TO PAGE Z5				

CHIUSINO CIRCOLARE

-  ROUND manhole cover
-  Trappe RONDE
-  Tapa CIRCULAR
-  RUNDE Klapptür
-  КРУГЛАЯ крышка люка
-  圆形人孔盖

980 SERIE
220/300/400/500/600 DN
Rev 01

COPERCHIO COVER	C
TELAIO FRAME	T
VOLANTINO HANDWHEEL	V
G. COPERCHIO G. COVER	GC
G. TELAIIO G. FRAME	GT

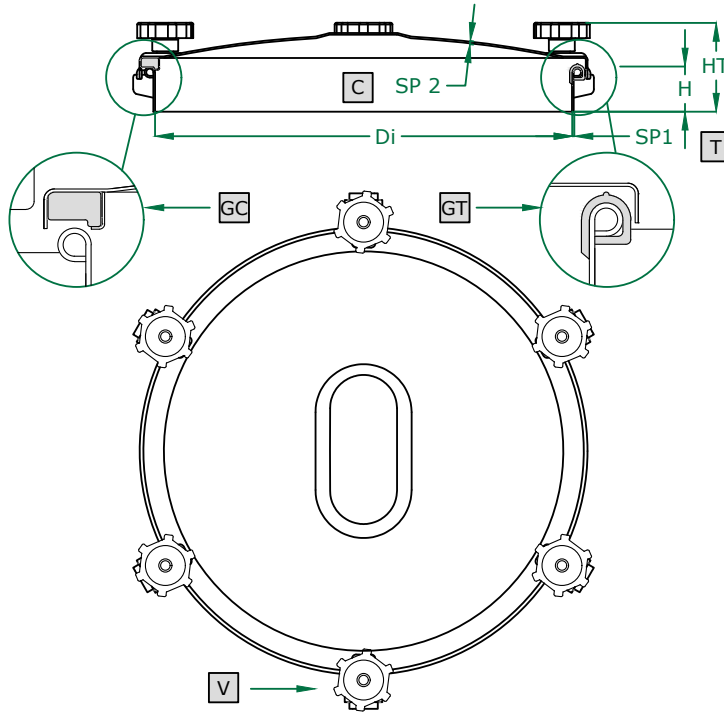

GUARNIZIONE TELAIIO / GASKET ON FRAME







ART	DN	Di	SP2	V (nr)	HT (standard)	BAR max: (standard)	COVER type:	GASKET code:	KG (standard)
979	220	220	1,5	3	105	0,2	CA	120 702	3,3
980	300	295	1,5	3	110	0,2	CA	120 703	4,5
982	400	395	1,5	4	112	0,2	CA	120 704	5,0
984	500	500	1,5	6	115	0,2	CA	120 705	7,5
985	600	600	1,5	6	115	0,2	CA	120 706	8,0

GUARNIZIONE COPERCHIO / GASKET ON COVER

ART	DN	Di	SP2	V (nr)	HT (standard)	BAR max: (standard)	COVER type:	GASKET code:	KG (standard)
979B	220	220	1,5	3	105	0,2	CA	120 802	3,5
980B	300	295	1,5	3	110	0,2	CA	120 803	4,8
982B	400	395	1,5	4	112	0,2	CA	120 804	5,4
984B	500	500	1,5	6	115	0,2	CA	120 805	7,9
985B	600	600	1,5	6	115	0,2	CA	120 806	8,5

	STANDARD	OPTIONAL				
H X SP1	60 X 2	100 X 2	150 X 2	200 X 2	250 X 2	...
TELAIO	SAT	MPL		BA		FIO
GUARNIZIONE	PARA	EPDM	NEOPRENE	NBR	SILICONE	VITON
VOLANTINO	125 001 V NYLON	125 021 V NYLON	125 022 CHROME P.	125 023 S. STEEL	125 024 ALUMINIUM	125 031 S. STEEL
FORO	NO	33	42	48	50	...
VALVOLA	NO	VAI ALLA PAG. Z5 / GO TO PAGE Z5				

CHIUSINO CIRCOLARE apertura a ribaltamento

-  ROUND manhole cover with back-side opening
-  Trappe RONDE avec ouverture par renversement
-  Tapa circular con apertura vertical
-  RUNDE Klapptür flapdoor
-  КРУГЛАЯ крышка люка с откидным открытием
-  圆形人孔盖

1020 SERIE

300/400/500/600 DN

Rev 0

COPERCHIO COVER	C
TELAIO FRAME	T
BRACCIO ARM	B
VOLANTINO HANDWHEEL	V
G. COPERCHIO G. COVER	GC
G. TELAIO G. FRAME	GT

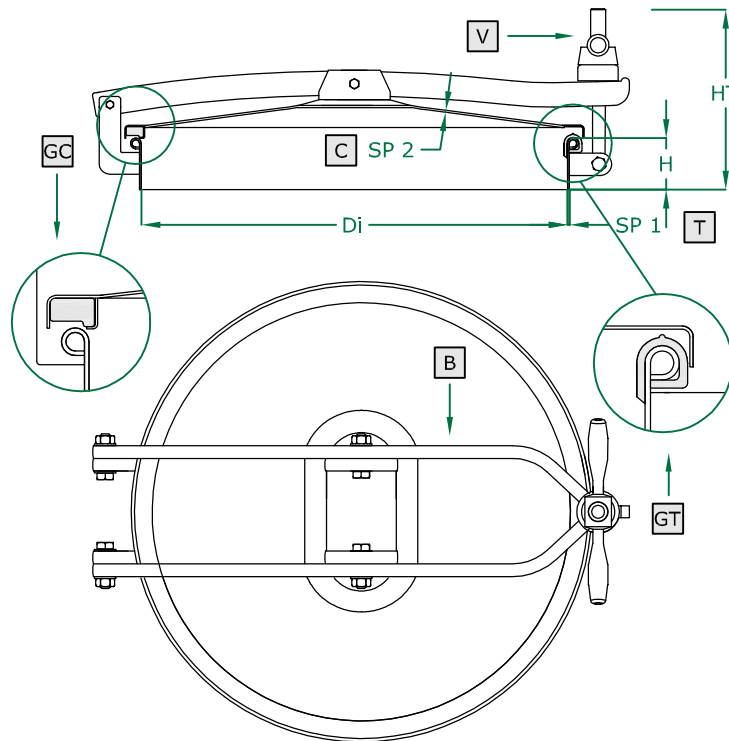

GUARNIZIONE TELAIO / GASKET ON FRAME

ART	DN	Di	SP2	HT (standard)	BAR max: (standard)	COVER type:	GASKET code:	KG (standard)
1020	300	295	1,5	110	0,4	CA	120 703	5,5
1022	400	395	1,5	112	0,4	CA	120 704	7,0
1024	500	500	1,5	115	0,4	CA	120 705	9,0
1025	600	600	1,5	115	0,4	CA	120 706	10,7



GUARNIZIONE COPERCHIO / GASKET ON COVER

ART	DN	Di	SP2	HT (standard)	BAR max: (standard)	COVER type:	GASKET code:	KG (standard)
1020B	300	295	1,5	110	0,4	CA	120 803	5,8
1022B	400	395	1,5	112	0,4	CA	120 804	7,0
1024B	500	500	1,5	115	0,4	CA	120 805	9,8
1025B	600	600	1,5	115	0,4	CA	120 806	11,5

Volantini M14

	STANDARD	OPTIONAL				
H X SP1	60 X 2	100 X 2	150 X 2	200 X 2	250 X 2	...
TELAIO	SAT	MPL		BA		FIO
GUARNIZIONE	PARA	EPDM	NEOPRENE	NBR	SILICONE	VITON
VOLANTINO	125 011 V NYLON			125 033 S. STEEL		
FORO	NO	33	42	48	50	...
VALVOLA	NO	VAI ALLA PAG. Z5 / GO TO PAGE Z5				

CHIUSINO CIRCOLARE

-  ROUND manhole cover
-  Trappe RONDE
-  Tapa CIRCULAR
-  RUNDE Klapptür
-  КРУГЛАЯ крышка люка
-  圆形人孔盖

1080 SERIE
800/1000/1200 DN
Rev 0

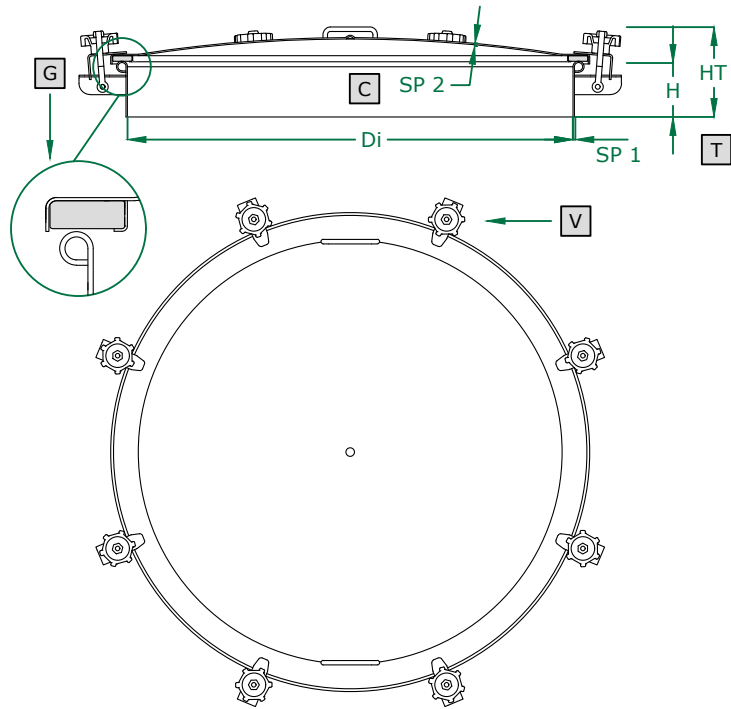

COPERCHIO COVER	C
TELAIO FRAME	T
VOLANTINO HANDWHEEL	V
GUARNIZIONE GASKET	G

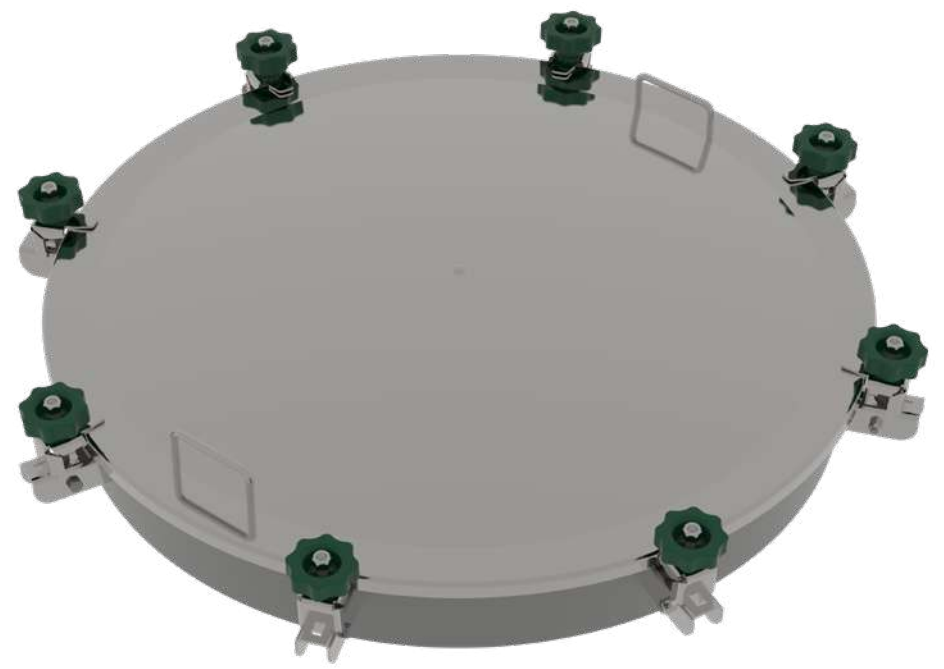



	STANDARD		OPTIONAL			
H X SP1	100 X 2,5	150 X 2,5
TELAIO	SAT					
GUARNIZIONE	SILICONE					
VOLANTINO	125 001 V NYLON					125 031 S. STEEL
FORO	NO	33	42	48	50	...
VALVOLA	NO VAI ALLA PAG. Z5 / GO TO PAGE Z5					

ART	DN	Di	SP2	V (nr)	HT (standard)	BAR max: (standard)	COVER type:	GASKET code:	KG (standard)
1080	800	800	2,5	8	165	0,2	CA	120 807 SIL	25,0
1081	1000	1000	2,5	10	185	0,2	CA	120 808 SIL	31,0
1082	1200	1200	2,5	12	185	0,2	CA	120 809 SIL	38,0

1090 SERIE

800/1000/1200 DN
Rev 0

CHIUSINO CIRCOLARE

-  ROUND manhole cover
-  Trappe RONDE
-  Tapa CIRCULAR
-  RUNDE Klapptür
-  КРУГЛАЯ крышка люка
-  圆形人孔盖

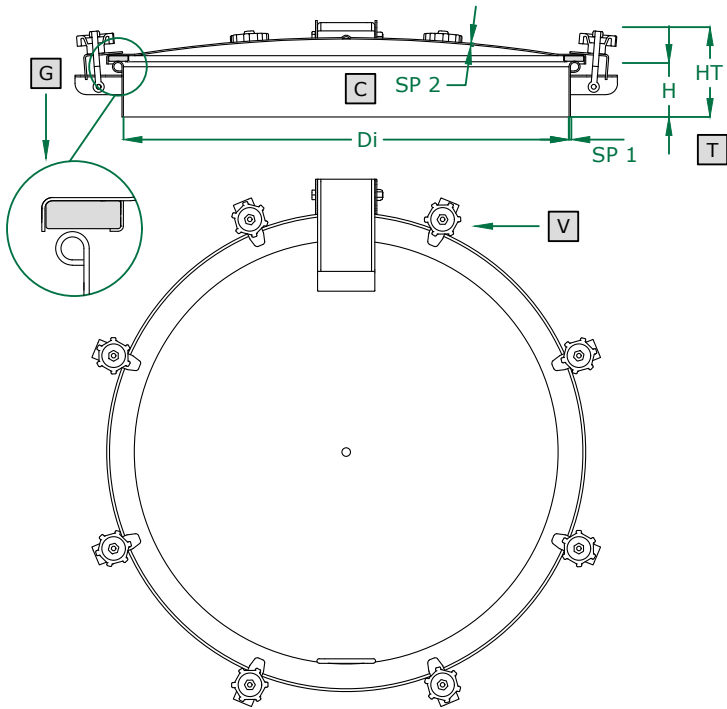

COPERCHIO COVER	C
TELAIO FRAME	T
VOLANTINO HANDWHEEL	V
GUARNIZIONE GASKET	G

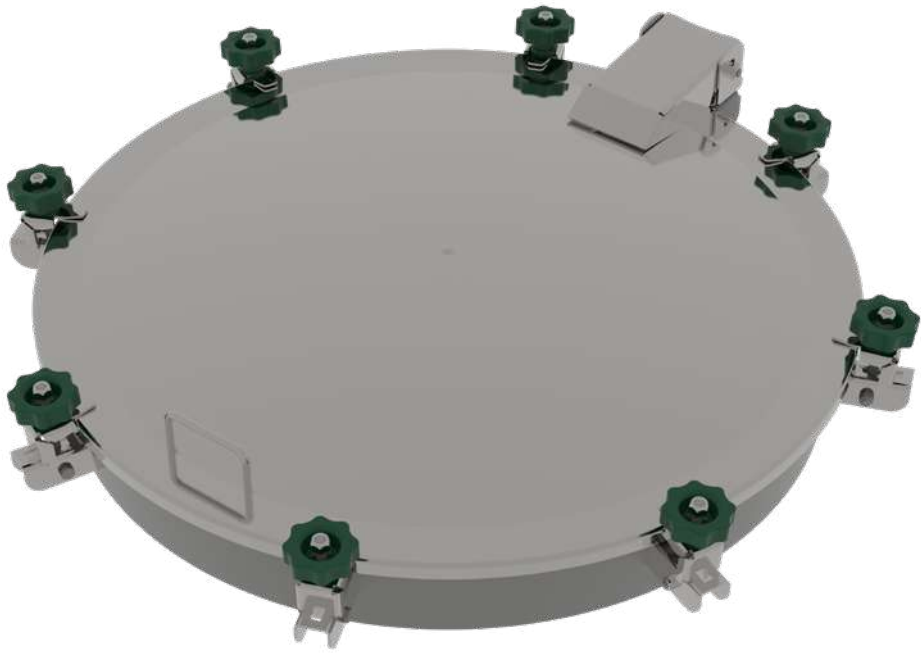







	STANDARD	OPTIONAL				
H X SP1	100 X 2,5	150 X 2,5
TELAIO	SAT					
GUARNIZIONE	SILICONE					
VOLANTINO	125 001 V NYLON					125 031 S. STEEL
FORO	NO	33	42	48	50	...
VALVOLA	NO	VAI ALLA PAG. Z5 / GO TO PAGE Z5				

ART	DN	Di	SP2	V (nr)	HT (standard)	BAR max: (standard)	COVER type:	GASKET code:	KG (standard)
1090	800	800	2,5	8	175	0,2	CA	120 807 SIL	27,0
1091	1000	1000	2,5	10	190	0,2	CA	120 808 SIL	33,0
1092	1200	1200	2,5	12	190	0,2	CA	120 809 SIL	39,0

Le immagini, i dati, i pesi, le caratteristiche tecniche a catalogo non sono impegnative. Ci riserviamo di apportare le modifiche necessarie, senza alcun preavviso. - The images, data, weights and technical specifications are not binding. We reserve the right to make the necessary alterations without prior notice.

CHIUSINO RETTANGOLARE apertura esterna

-  RECTANGULAR manhole cover outwards opening
-  Trappe RECTANGULAIRE avec ouverture à l'extérieur
-  Tapa RECTANGULAR de apertura externa
-  RECHTECKIGE Klapptür, Aussenöffnung
-  ПРЯМОУГОЛЬНАЯ крышка люка с внешним открытием
-  长方形人孔盖

651 ART
225 X 175 mm
Rev 0



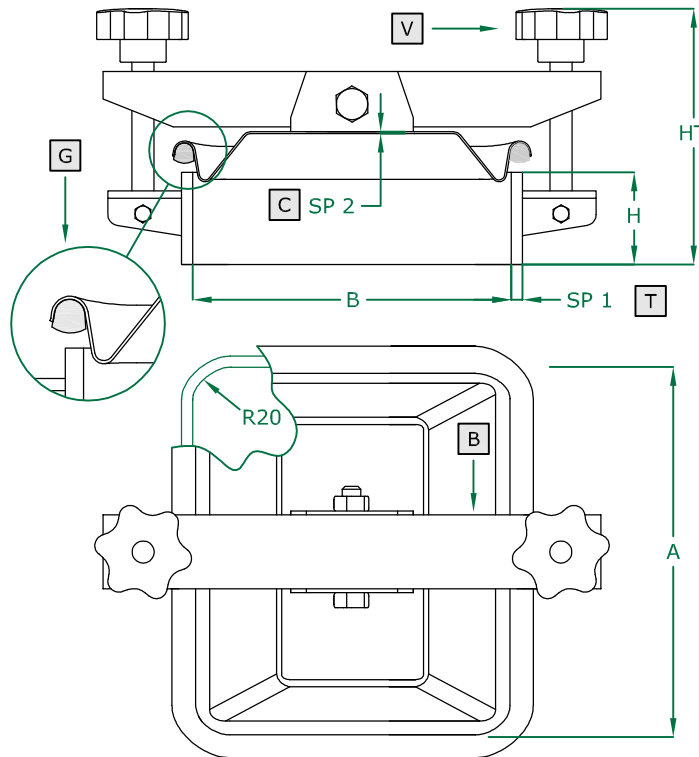



COPERCHIO COVER	C
TELAIO FRAME	T
BRACCIO ARM	B
VOLANTINO HANDWHEEL	V
GUARNIZIONE GASKET	G



	STANDARD		OPTIONAL			
H X SP1	50 X 6		30 X 6		100 X 6	
TELAIO	SAT		MPL			
GUARNIZIONE	EPDM	NEOPRENE	NBR	SILICONE	VITON	
VOLANTINO	125 001 V NYLON	125 021 V NYLON	125 022 CHROME P.	125 023 S. STEEL	125 024 ALUMINIUM	125 031 S: STEEL

ART	A	B	SP2	HT (standard)	BAR max: (standard)	COVER type:	GASKET code:	KG (standard)
651	223	174	1	145	0,3	CN	120 613	3,6

CHIUSINO RETTANGOLARE apertura esterna

-  RECTANGULAR manhole cover outwards opening
-  Trappe RECTANGULAIRE avec ouverture à l'extérieur
-  Tapa RECTANGULAR de apertura externa
-  RECHTECKIGE Klapptür, Aussenöffnung
-  ПРЯМОУГОЛЬНАЯ крышка люка с внешним открытием
-  长方形人孔盖

651L ART

175 X 225 mm
Rev 0



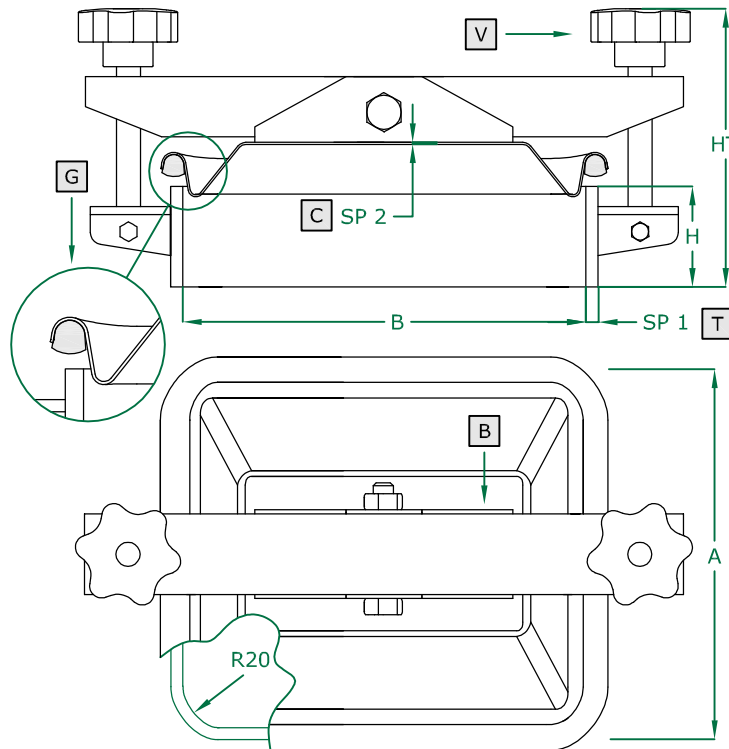



COPERCHIO COVER	C
TELAIO FRAME	T
BRACCIO ARM	B
VOLANTINO HANDWHEEL	V
GUARNIZIONE GASKET	G



	STANDARD		OPTIONAL			
H X SP1	50 X 6		30 X 6		100 X 6	
TELAIO	SAT		MPL			
GUARNIZIONE	EPDM	NEOPRENE	NBR	SILICONE	VITON	
VOLANTINO	125 001 V NYLON	125 021 V NYLON	125 022 CHROME P.	125 023 S. STEEL	125 024 ALUMINIUM	125 031 S. STEEL

ART	A	B	SP2	HT (standard)	BAR max: (standard)	COVER type:	GASKET code:	KG (standard)
651L	174	223	1	145	0,3	CN	120 613	3,8

CHIUSINO RETTANGOLARE apertura esterna

-  RECTANGULAR manhole cover outwards opening
-  Trappe RECTANGULAIRE avec ouverture à l'extérieur
-  Tapa RECTANGULAR de apertura externa
-  RECHTECKIGE Klapptür, Aussenöffnung
-  ПРЯМОУГОЛЬНАЯ крышка люка с внешним открытием
-  长方形人孔盖

652 ART
310 X 245 mm
Rev 0



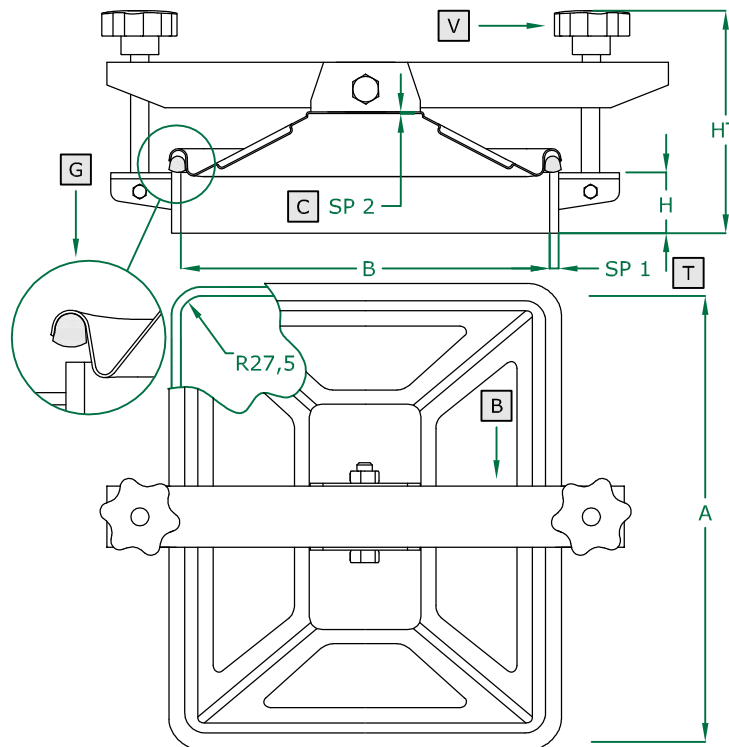



COPERCHIO COVER	C
TELAIO FRAME	T
BRACCIO ARM	B
VOLANTINO HANDWHEEL	V
GUARNIZIONE GASKET	G



	STANDARD		OPTIONAL			
H X SP1	50 X 6		30 X 6		100 X 6	
TELAIO	SAT		MPL			
GUARNIZIONE	PARA	EPDM	NEOPRENE	NBR	SILICONE	VITON
VOLANTINO	125 001 V NYLON	125 021 V NYLON	125 022 CHROME P.	125 023 S. STEEL	125 024 ALUMINIUM	125 031 S. STEEL

ART	A	B	SP2	HT (standard)	BAR max: (standard)	COVER type:	GASKET code:	KG (standard)
652	312	245	1,0	145	0,3	CN	120 615	5,2

CHIUSINO RETTANGOLARE apertura esterna

-  RECTANGULAR manhole cover outwards opening
-  Trappe RECTANGULAIRE avec ouverture à l'extérieur
-  Tapa RECTANGULAR de apertura externa
-  RECHTECKIGE Klapptür, Aussenöffnung
-  ПРЯМОУГОЛЬНАЯ крышка люка с внешним открытием
-  长方形人孔盖

652L ART
245 X 310 mm
Rev 0



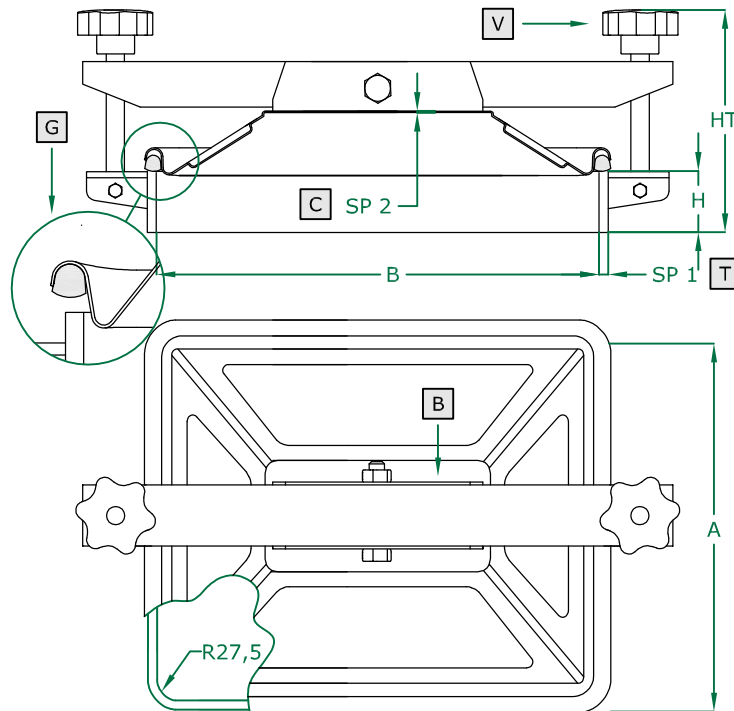



COPERCHIO COVER	C
TELAIO FRAME	T
BRACCIO ARM	B
VOLANTINO HANDWHEEL	V
GUARNIZIONE GASKET	G



	STANDARD		OPTIONAL			
H X SP1	50 X 6		30 X 6		100 X 6	
TELAIO	SAT		MPL			
GUARNIZIONE	PARA	EPDM	NEOPRENE	NBR	SILICONE	VITON
VOLANTINO	125 001 V NYLON	125 021 V NYLON	125 022 CHROME P.	125 023 S. STEEL	125 024 ALUMINIUM	125 031 S. STEEL

ART	A	B	SP2	HT (standard)	BAR max: (standard)	COVER type:	GASKET code:	KG (standard)
652L	245	312	1,0	145	0,3	CN	120 615	5,4

CHIUSINO RETTANGOLARE apertura esterna

-  RECTANGULAR manhole cover outwards opening
-  Trappe RECTANGULAIRE avec ouverture à l'extérieur
-  Tapa RECTANGULAR de apertura externa
-  RECHTECKIGE Klapptür, Aussenöffnung
-  ПРЯМОУГОЛЬНАЯ крышка люка с внешним открытием
-  长方形人孔盖

653 ART
360 X 275 mm
Rev 0



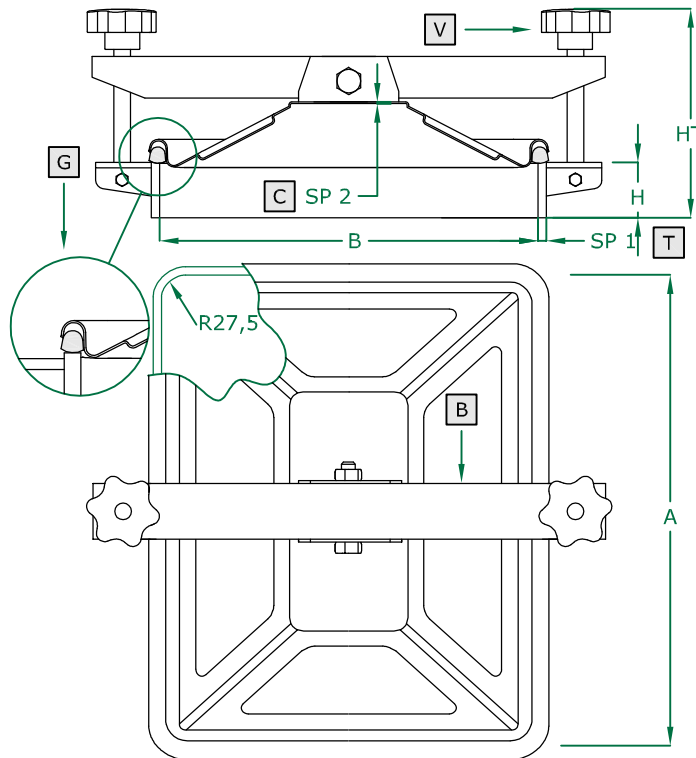



COPERCHIO COVER	C
TELAIO FRAME	T
BRACCIO ARM	B
VOLANTINO HANDWHEEL	V
GUARNIZIONE GASKET	G



	STANDARD		OPTIONAL			
H X SP1	50 X 6		100 X 6			
TELAIO	SAT		MPL			
GUARNIZIONE	PARA	EPDM	NEOPRENE	NBR	SILICONE	VITON
VOLANTINO	125 001 V NYLON	125 021 V NYLON	125 022 CHROME P.	125 023 S. STEEL	125 024 ALUMINIUM	125 031 S. STEEL

ART	A	B	SP2	HT (standard)	BAR max: (standard)	COVER type:	GASKET code:	KG (standard)
653	365	275	1,0	150	0,1	CN	120 617	6,0

CHIUSINO RETTANGOLARE apertura esterna

-  RECTANGULAR manhole cover outwards opening
-  Trappe RECTANGULAIRE avec ouverture à l'extérieur
-  Tapa RECTANGULAR de apertura externa
-  RECHTECKIGE Klapptür, Aussenöffnung
-  ПРЯМОУГОЛЬНАЯ крышка люка с внешним открытием
-  长方形人孔盖

653L ART
275 X 360 mm
Rev 0



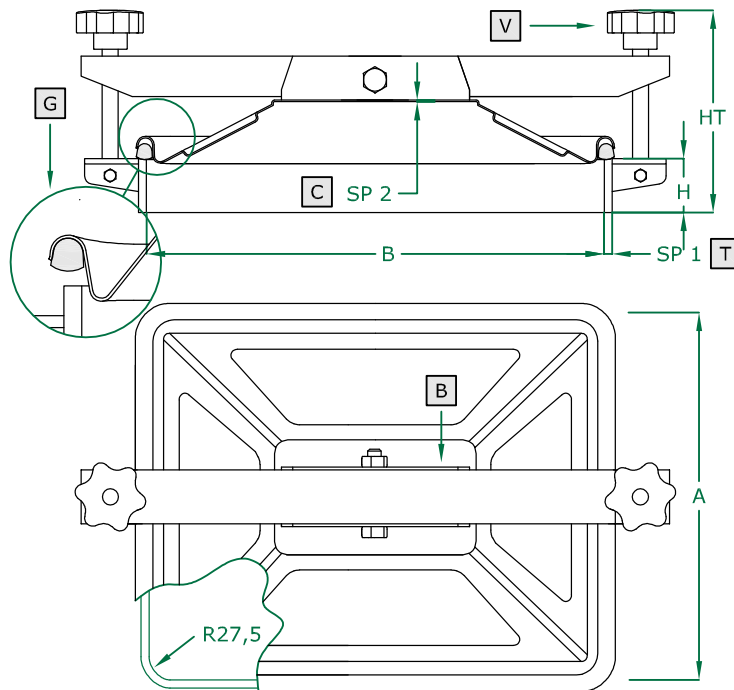



COPERCHIO COVER	C
TELAIO FRAME	T
BRACCIO ARM	B
VOLANTINO HANDWHEEL	V
GUARNIZIONE GASKET	G



	STANDARD		OPTIONAL			
H X SP1	50 X 6		100 X 6			
TELAIO	SAT		MPL			
GUARNIZIONE	PARA	EPDM	NEOPRENE	NBR	SILICONE	VITON
VOLANTINO	125 001 V NYLON	125 021 V NYLON	125 022 CHROME P.	125 023 S. STEEL	125 024 ALUMINIUM	125 031 S. STEEL

ART	A	B	SP2	HT (standard)	BAR max: (standard)	COVER type:	GASKET code:	KG (standard)
653L	275	365	1,0	150	0,1	CN	120 617	6,5

CHIUSINO RETTANGOLARE apertura esterna

-  RECTANGULAR manhole cover outwards opening
-  Trappe RECTANGULAIRE avec ouverture à l'extérieur
-  Tapa RECTANGULAR de apertura externa
-  RECHTECKIGE Klapptür, Aussenöffnung
-  ПРЯМОУГОЛЬНАЯ крышка люка с внешним открытием
-  长方形人孔盖

654 ART
400 X 280 mm
Rev 0



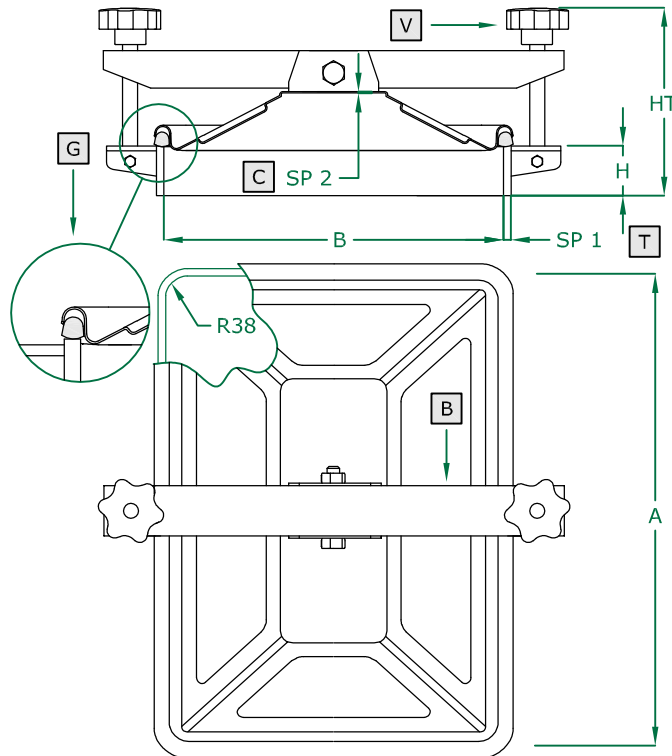



COPERCHIO COVER	C
TELAIO FRAME	T
BRACCIO ARM	B
VOLANTINO HANDWHEEL	V
GUARNIZIONE GASKET	G



	STANDARD		OPTIONAL			
H X SP1	50 X 6		100 X 6			
TELAIO	SAT		MPL			
GUARNIZIONE	PARA	EPDM	NEOPRENE	NBR	SILICONE	VITON
VOLANTINO	125 001 V NYLON	125 021 V NYLON	125 022 CHROME P.	125 023 S. STEEL	125 024 ALUMINIUM	125 031 S. STEEL

ART	A	B	SP2	HT (standard)	BAR max: (standard)	COVER type:	GASKET code:	KG (standard)
654	405	275	1,0	155	0,1	CN	120 617	6,5

CHIUSINO RETTANGOLARE apertura esterna

-  RECTANGULAR manhole cover outwards opening
-  Trappe RECTANGULAIRE avec ouverture à l'extérieur
-  Tapa RECTANGULAR de apertura externa
-  RECHTECKIGE Klapptür, Aussenöffnung
-  ПРЯМОУГОЛЬНАЯ крышка люка с внешним открытием
-  长方形人孔盖

654L ART
280 X 400 mm
Rev 0

COPERCHIO COVER	C
TELAIO FRAME	T
BRACCIO ARM	B
VOLANTINO HANDWHEEL	V
GUARNIZIONE GASKET	G

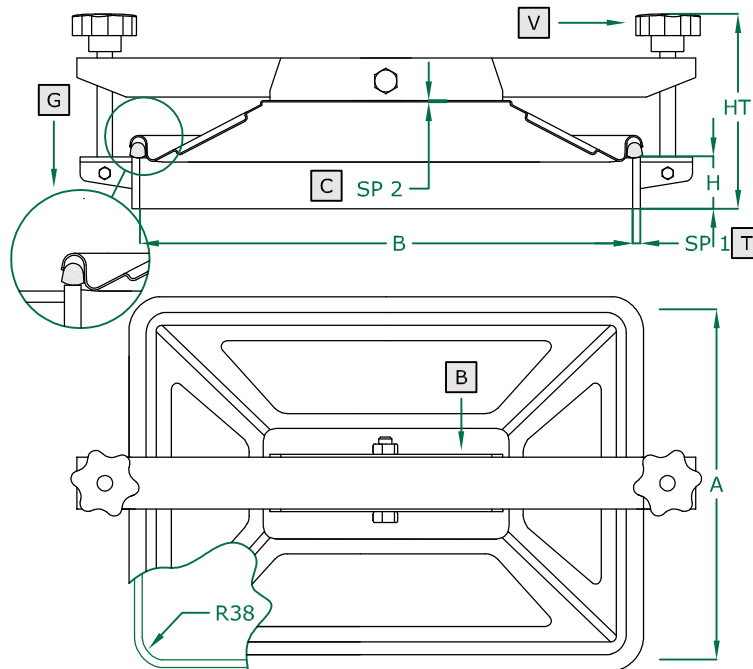





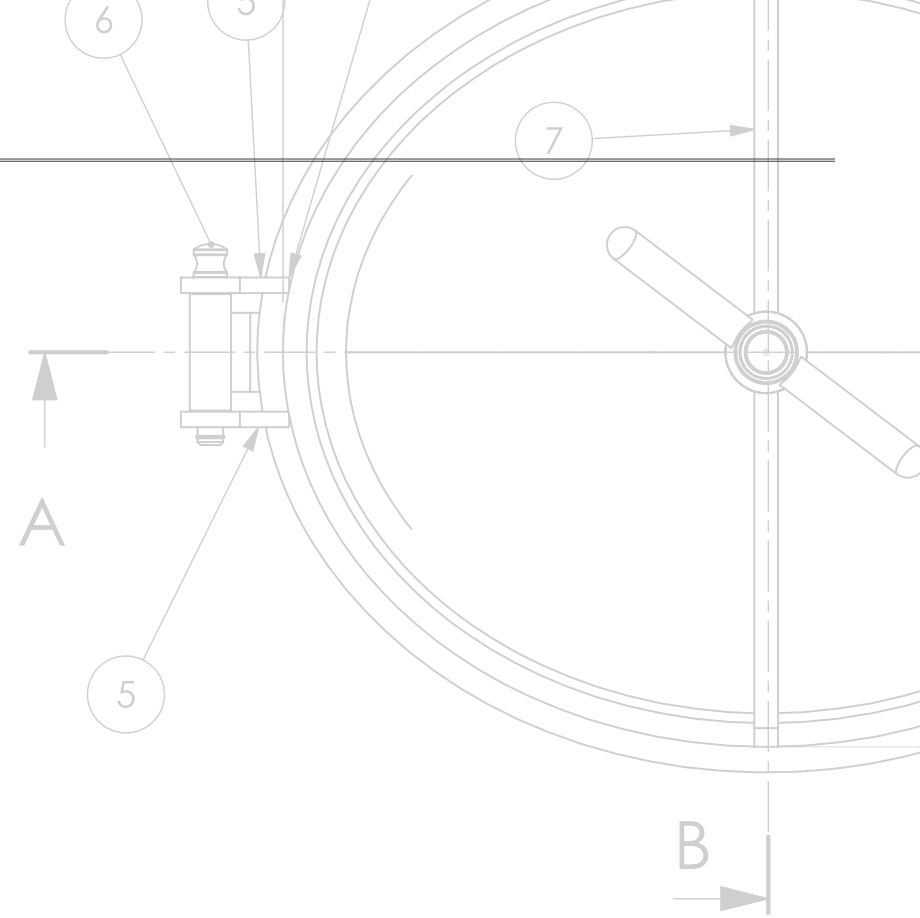

	STANDARD		OPTIONAL			
H X SP1	50 X 6		100 X 6			
TELAIO	SAT		MPL			
GUARNIZIONE	PARA	EPDM	NEOPRENE	NBR	SILICONE	VITON
VOLANTINO	125 001 V NYLON	125 021 NYLON	125 022 CHROME P.	125 023 S. STEEL	125 024 ALLUMINIUM	125 031 S.STEEL

ART	A	B	SP2	HT (standard)	BAR max: (standard)	COVER type:	GASKET code:	KG (standard)
654L	275	405	1,0	155	0,1	CN	120 617	7,0

Z-1



- Volantini  
- Handwheels  
- Volants  
- Volantes  
- Handräder  
- ЛИСТОВКИ  



125 000 - VOLANTINO D.50 IN NYLON M8

■ COD: 125 000 N - RAL 5004

Inserto M8 in ottone

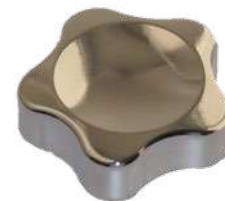

125 022 - VOLANTINO D.50 IN PA M10

COD: 125 022 - CROMO LUCIDO



125 001 - VOLANTINO D.70 IN NYLON M10

■ COD: 125 001 N - RAL 5004

■ COD: 125 001 V - RAL 6029

■ COD: 125 001 B - RAL 5015

Inserto M10 in ottone



125 023 - VOLANTINO D.50 IN INOX M10

COD: 125 023 - MPL



125 031 - VOLANTINO IN INOX M10

COD: 125 031



125 024 - VOLANTINO D.50 IN ALLUMINIO M10

COD: 125 024 - LUCIDO



125 021 - VOLANTINO D.70 IN NYLON M10 - FRIZIONE

■ COD: 125 021 N - RAL 5004

■ COD: 125 021 V - RAL 6029

■ COD: 125 021 B - RAL 5015

Inserto M10 in ottone



125 002 - VOLANTINO D.70 IN NYLON M12

■ COD: 125 002 N - RAL 5004

■ COD: 125 002 V - RAL 6029

■ COD: 125 001 B - RAL 5015

Inserto M12 in ottone

125 003 - VOLANTINO D.70 IN NYLON M14

■ COD: 125 003 N - RAL 5004

■ COD: 125 003 V - RAL 6029

Inserto M14 in ottone

125 011 - VOLANTINO D.135 IN NYLON M14

■ COD: 125 011 N - RAL 5004

■ COD: 125 011 V - RAL 6029

■ COD: 125 011 B - RAL 5015

Inserto M14 in ottone

125 004 - VOLANTINO D.135 IN NYLON M16

■ COD: 125 004 N - RAL 5004

■ COD: 125 004 V - RAL 6029

■ COD: 125 004 B - RAL 5015

Inserto M16 in ottone



COD: 125 033 - M14

COD: 125 034 - M16

COD: 125 037 - M22

125 010 - VOLANTINO D.135 IN NYLON QUADRO 10x10

■ COD: 125 010 N - RAL 5004

■ COD: 125 010 V - RAL 6029

■ COD: 125 010 B - RAL 5015

125 040 - VOLANTINO IN INOX QUADRO 10x10

COD: 125 040

125 012 - VOLANTINO D.165 IN NYLON QUADRO 15x15

■ COD: 125 012 N - RAL 5004

■ COD: 125 012 V - RAL 6029

■ COD: 125 012 B - RAL 5015

125 042 - VOLANTINO IN INOX QUADRO 15x15

COD: 125 042

Z-5

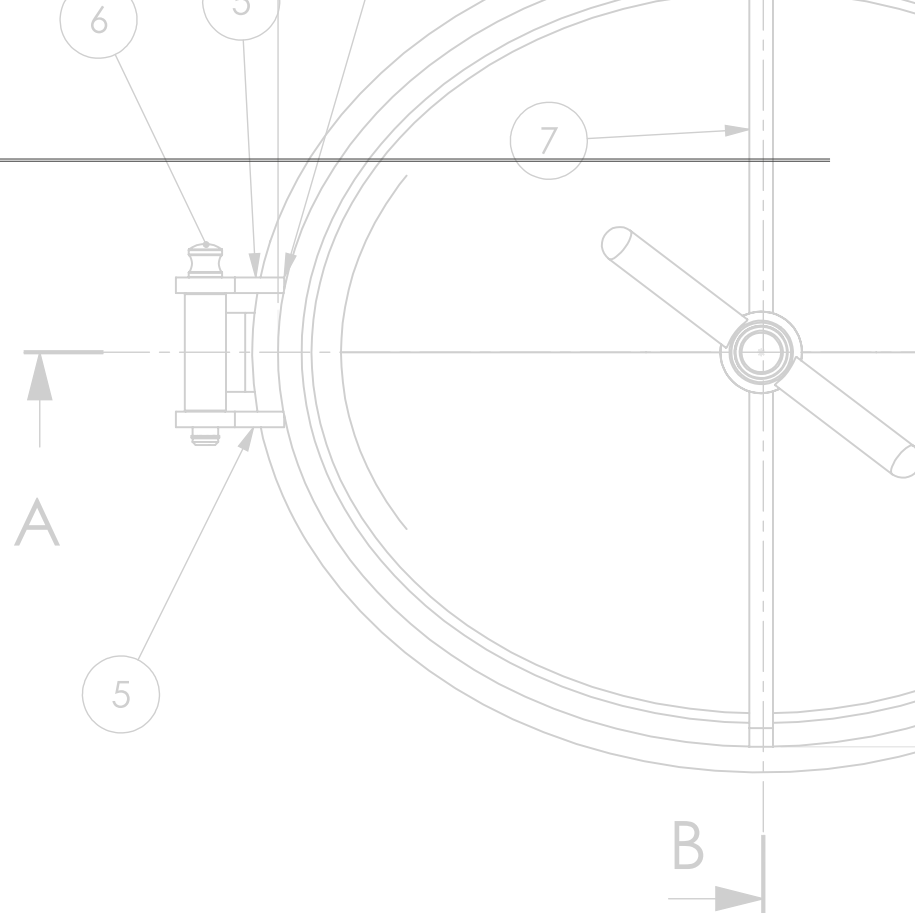

Valvole di sfiato



Relief valve



Soupape



Válvula de desaireación



Entlüftungsventile



Предохранительные клапаны





1380 ART

Valvola di sfato in Polyetilene
Pressure relief valve in polyethylene

COD:	MATERIALE	Attacco	Foro Coperchio	PORTATA
126 105	P.E.	1" 1/2	F 48	500 hl / h



1381 ART

Valvola di sfato a doppio effetto per tenuta azoto
Double action relief valve for nitrogen estate

COD:	MATERIALE	DN	Foro Telaio	PORTATA
126 001A	AISI304 /316	40	F 42	200 hl / h
126 001B	AISI304 /316	50	F 50	300 hl / h
126 001C	AISI304 /316	80	F 85	500 hl / h



1382 ART

Valvola di sfato in Polyetilene
Pressure relief valve in polyethylene

COD:	MATERIALE	Attacco	Foro Coperchio	PORTATA
126 108	P.E.	1" 1/2	F 48	500 hl / h



1383 ART

Valvola di sfato in Polyetilene
Pressure relief valve in polyethylene

COD:	MATERIALE	Attacco	Foro Coperchio	PORTATA
126 109	P.E.	2"	F 60	800 hl / h



1384 ART

Valvola di sfiato in Polietilene
Pressure relief valve in polyethylene

COD:	MATERIALE	Attacco	Foro Coperchio	PORTATA
126 106	P.E.	1" 1/4	F 42	250 hl / h
126 107	P.E.	1" 1/2	F 48	250 hl / h



1385 ART

**Valvola di sfiato, a doppio effetto (pressione e depressione)
con funzionamento a bagno d'olio**
Relief valve, two-way (pressure and vacuum) with oil bath
working

FINITURA STANDARD MPL / FINITURA SPECIALE LUCIDA MMP

COD:	MATERIALE	DN	Foro Coperchio	PORTATA
126 002A	AISI304 /316	60	F 60,3	500 hl / h
126 002B	AISI304 /316	70	F 76,1	500 hl / h
126 002C	AISI304 /316	80	F 88,9	1000 hl / h
126 002D	AISI304 /316	100	F 101,6	1000 hl / h



1386 ART

**Valvola di sfiato, a doppio effetto (pressione e depressione)
con funzionamento a bagno d'olio**
Relief valve, two-way (pressure and vacuum) with oil bath
working

COD:	MATERIALE	DN	Foro Telaio	PORTATA
126 003A	AISI304 /316	60	F 60,3	500 hl / h
126 003B	AISI304 /316	70	F 76,1	500 hl / h
126 003C	AISI304 /316	80	F 88,9	1000 hl / h
126 003D	AISI304 /316	100	F 101,6	1000 hl / h



1387 ART

**Valvola a doppio effetto in PVC DN 50 con raccordo DIN in
acciaio inox**

Pressure relief PVC valve DN 50 with stainless steel DIN male

COD:	MATERIALE	Attacco	Foro Coperchio	PORTATA	RACCORDO DIN A SALDARE
126 104	PVC	DIN 50	F 53	300 hl / h	SI
126 104B	PVC	DIN 50	F 53	300 hl / h	NO